PRODUCT CATALOGUE

SF₆-insulated Ring Main Unit, SafeRing 36 and SF₆-insulated Compact Switchgear SafePlus 36



- Compact and extendable modular
- Climatically independent
- Corrosion classification C4H

Table of contents

004 – 005	Applications SafeRing 36
006 – 007	Applications SafePlus 36
008	Design philosophy
009 – 011	SafeRing 36 configurations
012	Technical data safeRing
013	SafePlus 36 modules
014	C - Cable switch
015	F - Switch-fuse disconnecter
016 – 017	V - Vacuum circuit-breaker
018	D - Direct cable connection
019	De - Direct cable connection with earthing switch
020	M - Metering module
021	Outer assembly
022	Cable switch module
023	Switch-fuse module
024	Vacuum circuit-breaker module
025	Cable bushings

026	Completely sealed enclosure
027 – 028	Mechanisms and interlocks
029	Side extension
030	Low voltage compartment
031 – 032	Motor operation and coils
033	Transformer protection
034	Fuse selection table - CEF
035	Fuses
036 – 037	Relays
038 – 039	Combisensor
040	Cable terminations
041	Short-circuit indication and Phase comparators
042	Ronis key interlocks
043 – 046	Dimensions
047 – 052	Technical data
053	Environmental certification
054	ISO-Certificates

Applications SafeRing 36

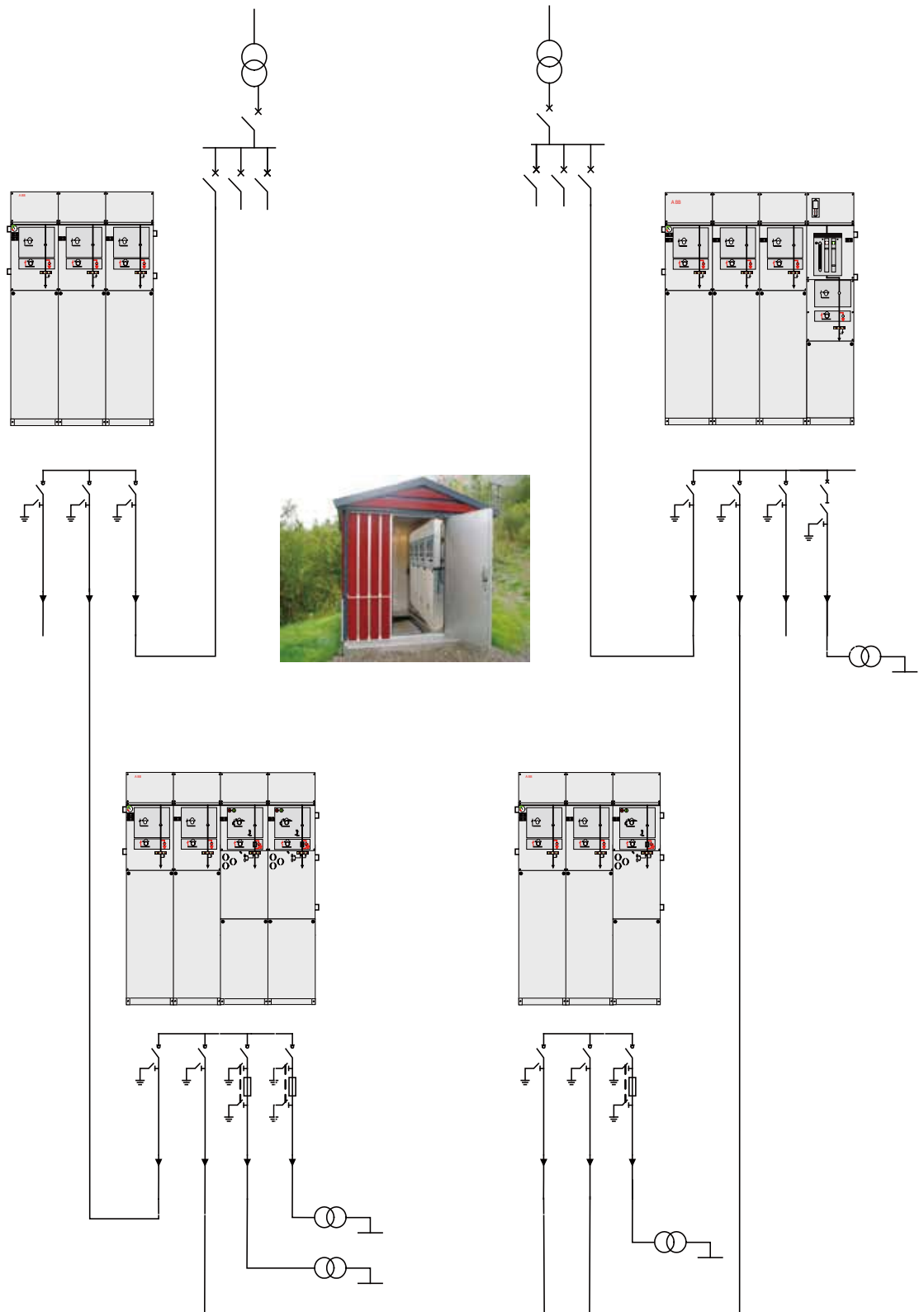

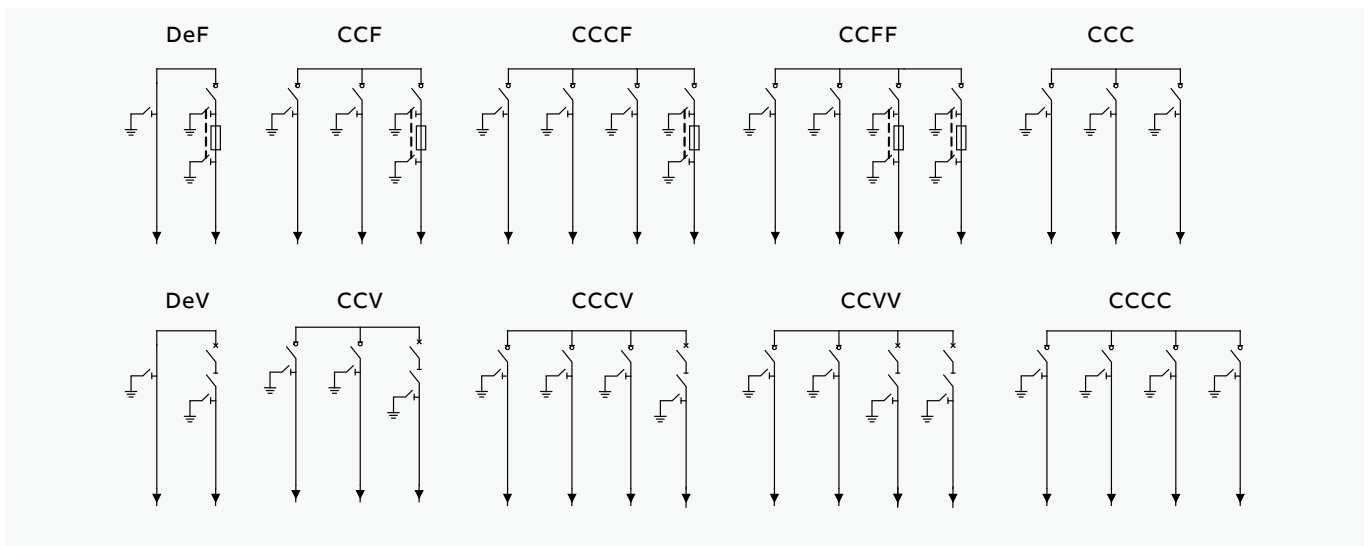

SafeRing 36 is a ring main unit for the secondary distribution network. SafeRing 36 is available in 5 different configurations suitable for most switching applications in 36 and 40,5 kV distribution networks. SafeRing is extendible and can be combined with SafePlus. SafePlus is ABB's flexible compact switchgear. Together they represent a complete solution for 36 kV secondary distribution networks. SafeRing 36 and Safe-Plus 36 have identical user interfaces.

SafeRing 36 is a completely sealed system with a stainless steel tank containing all live parts and switching functions. A hermetically sealed stainless steel tank with constant atmospheric conditions ensures a high level of reliability as well as personnel safety and a virtually maintenance-free system.

SafeRing 36 is designed for use in the following applications:

- Compact secondary substations
- Small industries
- Wind power plants
- Hotels, shopping centres, office buildings, business centers etc

C Cable switch

De Direct cable connection with earthing switch

F Switch-fuse-disconnector

V Vacuum circuit-breaker

Applications SafePlus 36

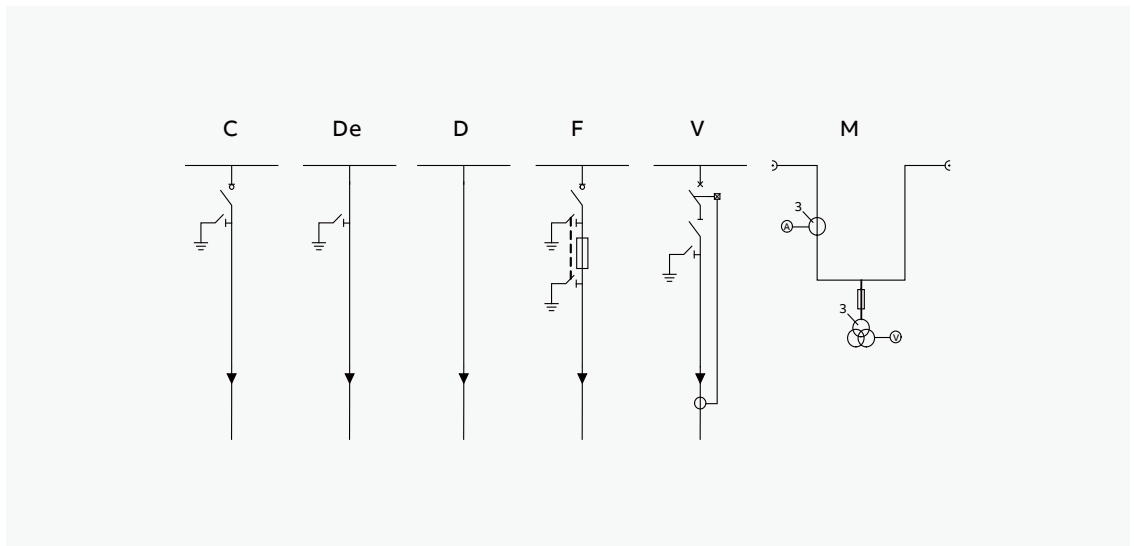

SafePlus 36 is designed for customised application of switchgear in:

- Compact secondary substations
- Small industries
- Wind power plants
- Hotels, shopping centres, office buildings, business centers etc

- C Cable switch
- De Direct cable connection with earthing
- D Direct cable connection
- F Switch-fuse-disconnector
- V Vacuum circuit-breaker
- M Metering module (air-insulated)

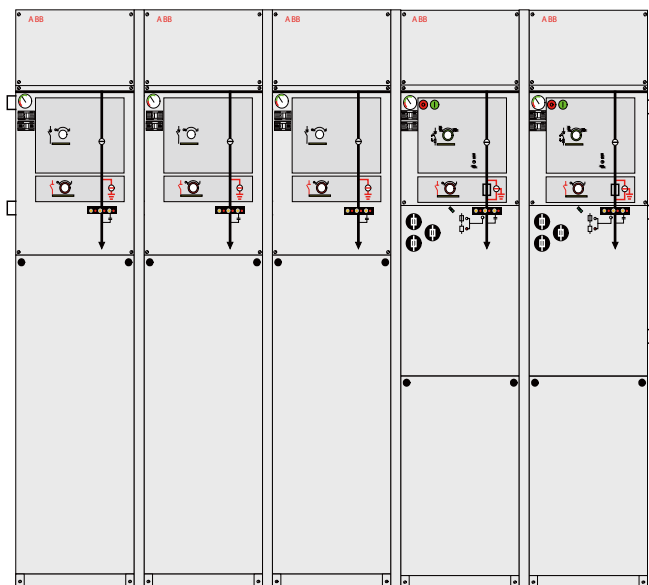

SafePlus 36 compact switchgear in fully modular design, typical configuration:

- 3 pcs.1-way units of cable switches
- 2 pcs.1-way units of switch-fuse-disconnectors

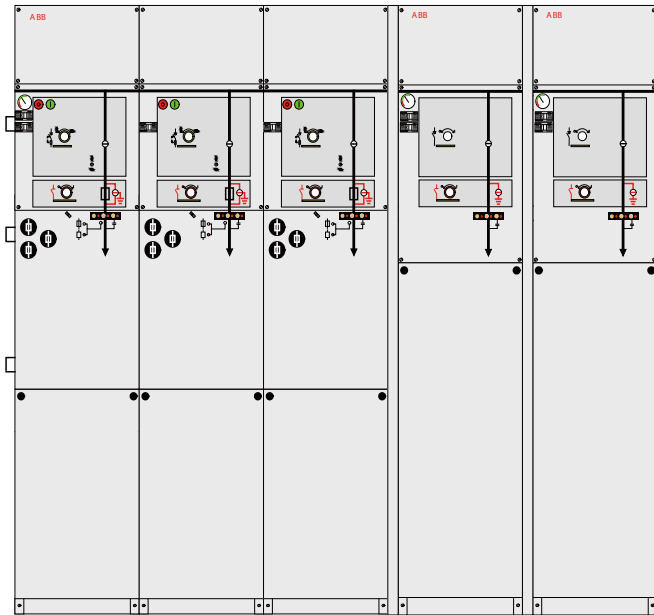

SafePlus 36 compact switchgear, typical configuration:

- 3-way section consisting of 3 modules of switch-fusedisconnectors
- Extendible with 1 or more 1-way units

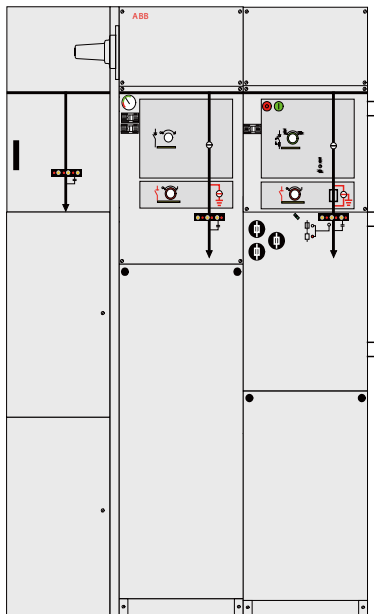

SafePlus 36 compact switchgear, typical windmill configuration:

- 1 pc. 1-way unit of cable switch with cable bushings on left hand side
- 1 pc. 1-way unit of vacuum circuit-breaker

Design philosophy

SafeRing and SafePlus – ABB switchgears for secondary distribution

Evolution: more functionality, compact dimensions. Secondary distribution switchgears have been subject to a significant development the recent 20 years.

The traditional switching cells are substituted with complete switchgear systems. Specific functions such as grounding, disconnecting, cable connections, busbar extension, protection and switching have become integrated features in compact functional units.

Compact switchgear systems fulfils customers MV application requirements. ABB has always taken an active part in this development.

The most unique specialisation is the development of the compact secondary switchgear. The numerous distribution substations requested a unified switching functionality that evolved into the ring main unit concept.

ABB SafeRing range is one major contributor to this specialisation.

Two Products – One range

ABB SafeRing is adapted to the needs in the utility distribution networks.

ABB SafePlus offers more flexibility and electrical capacity.

Both switchgears offer the same user interface.

Customers involvement:

The applied functionality in ABB SafeRing and SafePlus is a result of input from customers all over the world.

Key customers are continuously involved with ABB design staff to ensure optimised switchgear operation.

Personnel – safety operation

All products are designed and manufactured in compliance with ISO 9001, ISO 14001 and ISO 18001. The latest edition of relevant IEC standards will always apply to our continuous test programme.

Safety is not only a specification and rating issue, but also a real life experience.

All units are factory routine tested according to international standards. ABB takes this further to be an objective related to durability and repetitive manufacturing quality.

Features for further enhancing personnel safety are available. “Integrated functionality” is a key objective to reduce the number of moving components, further reducing the risk of any mechanical defect.

We are responsible for the environment

The location for manufacturing SafeRing and SafePlus is Norway. Green policy assures focus on environmental factors in manufacturing as well as over the switchgear’s life span.

All products are manufactured in accordance with our ISO 14001 certification. Materials are carefully selected, to ensure reuse at end of life. Recycling capability is 89% (for details see chapter 10).

To facilitate the recycling process we continuously work along with our partners to improve end of life handling.

Modern - development and manufacturing

Numerical simulations together with long experience ensure reliable and safe, compact and robust design.

Dielectric simulations ensure that compactness does not influence the dielectrical capability.

The combination of design techniques, experience and the most modern production technology guarantee state of the art products and durability.

Complete solutions – one supplier

Complex applications involving remote control and monitoring can be supplied from ABB.

This makes large scale implementation feasible, and will simplify engineering and procurement. The control and monitoring unit available for SafeRing 36 is located behind the front cover. This option is also available as retrofit.

SafeRing 36 configurations



SafeRing CCF

General

SafeRing 36 is an extendible ring main unit for the secondary distribution network. SafeRing 36 is available in 10 different configurations suitable for most switching applications up to 40.5 kV distribution networks.

SafeRing 36 is a completely sealed system with a stainless steel tank containing all live parts and switching functions. The sealed steel tank with constant atmospheric conditions ensures a high level of reliability, personnel safety and a virtually maintenance-free system.

The SafeRing 36 concept offers a choice between switch-fuse combination or circuit-breaker in combination with relay for protection of the transformer.

SafeRing 36 can be supplied with integrated remote control and monitoring unit.

SafeRing 36 is supplied with the following standard equipment

- Vacuum circuit-breaker
- Two-position load break puffer switch
- Earthing switch with single spring operating mechanism
- Switch position indication for load break switch and earthing switch
- Single spring operating mechanism on cable switches
- Two-position mechanism with auto-reclosing duty for vacuum circuit-breaker
- Double spring operating mechanism on switch-fusedisconnectors
- Cable bushings horizontal in front, 400 series bolted with integrated voltage divider for voltage indication
- Busbars, 630 A
- Earthing bar
- Operating handle
- Lifting lugs for easy handling
- Adjustable cable support bars
- Manometer for SF₆ pressure

Factory assembled options

- Bushings for extension busbar
- Interlocking
 - Cable compartment front cover interlocked with earthing switch
- Signal (1NO) from internal pressure indicator wired to terminals (one each SF₆-enclosure)

Additional equipment also available as retrofit

- Motor operation
- Trip coil open
- Trip coil open and close
- Aux. switch for load break switch 2NO + 2NC
- Aux. switch for earth switch 2NO + 2NC
- Aux. switch for fuse blown 1NO
- Aux. switch for vacuum circuit-breaker 2NO+2NC
- Capacitive voltage indication
- Short circuit indicator
- Cable cover for parallel cables
- Ronis key interlocking system
- Current measuring
- Sidewalls - painted

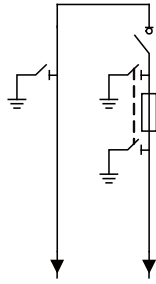
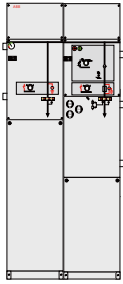

DeF
 Depth: 900 mm
 Width: 910 mm
 Height: 1930 mm

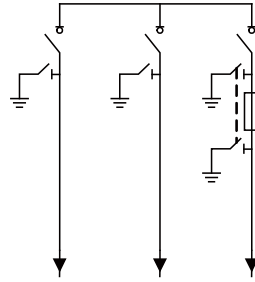
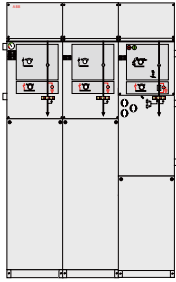

CCF
 Depth: 900 mm
 Width: 1330 mm
 Height: 1930 mm

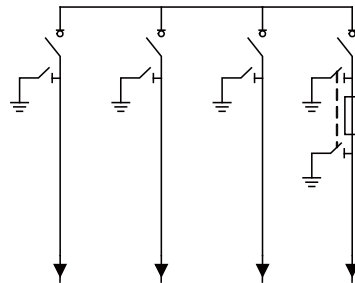
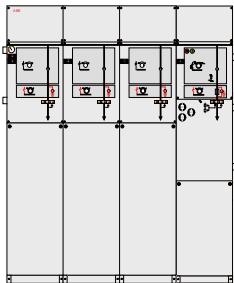

CCCF
 Depth: 900 mm
 Width: 1750 mm
 Height: 1930 mm

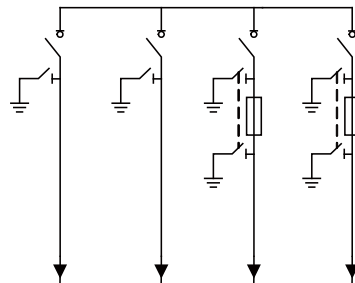
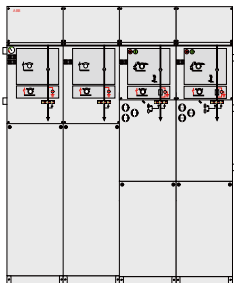

CCFF
 Depth: 900 mm
 Width: 1750 mm
 Height: 1930 mm

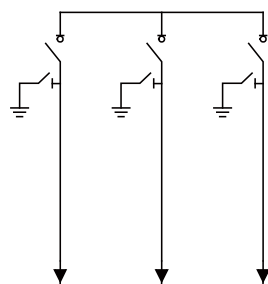
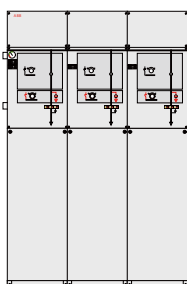

CCC
 Depth: 900 mm
 Width: 1330 mm
 Height: 1930 mm

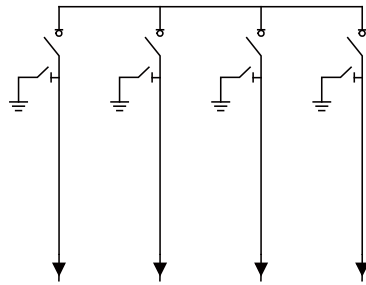
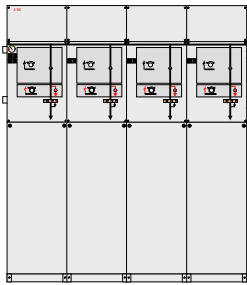

CCCC
 Depth: 900 mm
 Width: 1750 mm
 Height: 1930 mm

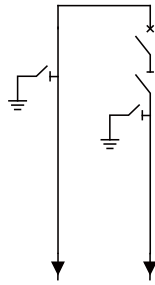
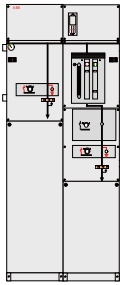

DeV
 Depth: 900 mm
 Width: 910 mm
 Height: 1930 mm

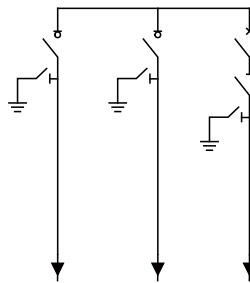
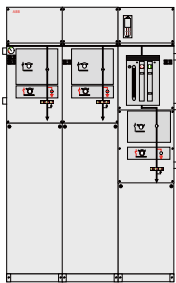

CCV
 Depth: 900 mm
 Width: 1330 mm
 Height: 1930 mm

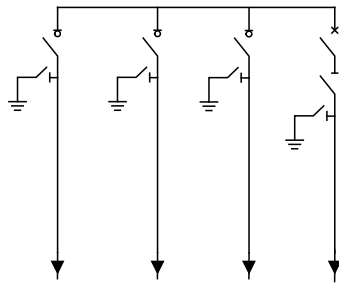
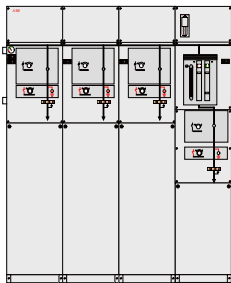

CCCV
 Depth: 900 mm
 Width: 1750 mm
 Height: 1930 mm

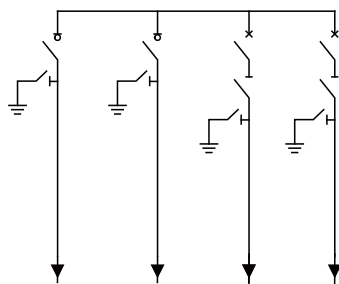
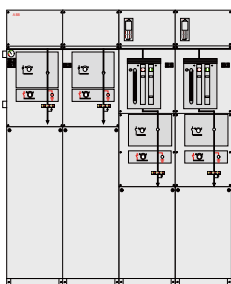

CCVV
 Depth: 900 mm
 Width: 1750 mm
 Height: 1930 mm

Technical data SafeRing

SafeRing 36	C-module		F-module		V-module		
	Switch disconnecter	Earthing switch	Switch-fuse disconnecter	Downstream earthing switch	Vacuum circuit-breaker	Earthing switch/ disconnecter	
Rated voltage	kV	36/38.5/40.5	36/38.5/40.5	36/38.5/40.5	36/38.5/40.5	36/38.5/40.5	36/38.5/40.5
Power frequency withstand voltage	kV	70/80/95	70/80/95	70/80/95	70/80/95	70/80/95	70/80/95
- Across disconnecter	kV	80/95/118		80/95/118			80/95/118
Lightning impulse withstand voltage	kV	170/180/185	170/180/185	170/180/185	170/180/185	170/180/185	170/180/185
- Across disconnecter	kV	195/210/215		195/210/215			195/210/215
Rated normal current	A	630/630/630		see ¹⁾		630/630/630	
Breaking capacities:							
- Active load	A	630/630/630					
- Closed loop	A	630/630/630					
- Off load cable charging	A	20/21/21				50/50/50 (Class C1)	
- Earth fault	A	60/63/63					
- Earth fault cable charging	A	35/36/36					
- Transfer current	A			840/750/750			
- Short-circuit breaking current	kA			see ²⁾		20/20/20 (Class E1, S1)	
Making capacity	kA	50/50/50 (5 times)	50/50/50 (5 times)	see ²⁾	2.5/2.5/2.5 (5 times)	50/50/50	50/50/50
Class (Electrical endurance)		E3/E2/E2	E2/E2/E2	- / -	E2/E2/E2	E1/E1/E1	E2/E2/E2
Short time current 1 sec.	kA				1/1/1		
Short time current 3 sec.	kA	20/20/20	20/20/20	see ²⁾		20/20/20	20/20/20
Internal arc classification IAC AFL, 1 s	kA	20/20/20		20/20/20		20/20/20	

1) Depending on the current rating of the fuse-link.

2) Limited by high voltage fuse-links.

SafeRing 36 is tested according to IEC publications IEC 60265-1, IEC 62271-100, -102, -105, -200, IEC 60529 and IEC 60694 for 36 and 38.5 kV. For 40.5 kV, testing is according to GB standards.

SafePlus 36 modules



SafePlus CF+C

SafePlus can also be supplied with or retrofitted with remote control and monitoring equipment.

SafePlus 36 is supplied with the following standard equipment:

- Operating handle
- Lifting lugs for easy handling
- Busbars, 630 A
- Earthing bar
- Adjustable cable support bars
- Manometer for SF₆ pressure

Factory assembled options

- Bushings for extension busbar
- Signal (1NO) from internal pressure indicator wired to terminals (one each SF₆-enclosure)

Additional equipment also available as retrofit

- Sidewalls - painted

General

SafePlus 36 is a metal enclosed compact switchgear system for up to 40,5 kV distribution applications. The switchgear has a unique flexibility due to its extensibility and the possible combination of fully modular and semi modular configurations.

SafePlus 36 is a completely sealed system with a stainless steel tank containing all the live parts and switching functions.

The sealed steel tank with constant atmospheric conditions ensures a high level of reliability, personnel safety and a virtually maintenance-free system. As an option a SafePlus switchgear can be equipped with a set of busbar connections left/right in order to obtain extension or full modularity.

The external busbar kit has to be mounted to the switchgears on site.

The SafePlus 36 system offers a choice between switch-fuse combination or circuit-breaker in combination with relay for protection of the transformer.

C - Cable switch

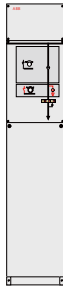

Depth: 900 mm
Width: 420 mm
Height: 1930 mm ^{*)}

^{*)} Height with high LV-compartment:
2180 mm

Standard features

- Two-position load break puffer switch and separate earthing switch
- Two-position single spring operating mechanisms with two separate operating shafts for load break function and earthing function
- Switch position indication for load break switch and earthing switch
- Cable bushings horizontal in front, 400 series bolted with integrated voltage divider for voltage indication
- Cable compartment cover allowing double cable connection
- Busbars, 630 A
- Earthing bar

Factory assembled options

- Interlocking
 - Cable compartment front cover interlocked with earthing switch

Additional equipment also available as retrofit

- Motor operation for load break switch
- Auxiliary switches
- Load break switch position 2NO+2NC
- Earthing switch position 2NO+2NC
- Capacitive voltage indicator
 - VPIS acc. to IEC 61958 with integrated indicator lamps (LED)
- Short circuit and earth fault indicator EKL1
- Cable cover for parallel cables
- External current transformers (CT)
- Ronis key interlock

Technical data

Switch disconnecter

Rated voltage	kV	36	38.5	40.5 ^{*)}
Power frequency withstand voltage	kV	70	80	95
- Across disconnecter	kV	80	95	118
Lightning impulse withstand voltage	kV	170	180	185
- Across disconnecter	kV	195	210	215
Rated normal current	A	630	630	630
Breaking capacities:				
- Active load	A	630	630	630
- Closed loop	A	630	630	630
- Off load cable charging	A	20	21	21
- Earth fault	A	60	63	63
- Earth fault cable charging	A	35	36	36
Making capacity	kA	50	50	50
		(5 times)	(5 times)	(5 times)

Class (Electrical endurance)	E3	E2	E2	
Short time current 1 sec. ^{**)}	kA	20	20	20
Short time current 3 sec.	kA	20	20	20
Internal arc classification IAC	kA	20	20	20

AFL, 1 sec

Number of mechanical operations 1000 close/open manual

Earthing switch

Rated voltage	kV	36	38.5	40.5
Power frequency withstand voltage	kV	70	80	95
Lightning impulse withstand voltage	kV	170	180	185
Making capacity	kV	50	50	50
		(5 times)	(5 times)	(5 times)

Short time current 1 sec. ^{**)}	kV	20	20	20
Short time current 3 sec.	kV	20	20	20
Class (Electrical endurance)	E2	E2	E2	

Number of mechanical operations 1000 close/open manual

^{*)} For 40,5 kV, testing is according to GB standards.

^{**)} Optional 25 kA.

F - Switch-fuse disconnecter

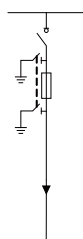
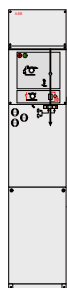

Depth: 900 mm
Width: 420 mm
Height: 1930 mm ^{*)}

^{*)} Height with high LV-compartment:
2180 mm

Standard features

- Fuse/transformer rating: 36 kV, max 63 A fuse-links
- Integrated load break switch two-position and separate upstream earthing switch mechanically linked with downstream earthing switch
- Switch position indication for switch-fuse-disconnector and earthing switches
- Double spring mechanism for switch-fuse-disconnector with two separate operating shafts for loadbreak function and earthing function
- Fuse canisters for DIN type fuse-links. Only accessible when earthing switch is closed
- Fuse tripping arrangement
- Optical fuse trip indication
- Cable bushings horizontal in front, 400 series boltes with integrated voltage divider for voltage indication
- Cable compartment allowing double cable connection
- Main busbars, 630 A
- Earthing bar

Factory assembled options

- Interlocking
 - Cable compartment front cover interlocked with earthing switch

Additional equipment also available as retrofit

- Motor operation for switch-fuse-disconnector
- Trip coil open
- Trip coil open and close
- Auxiliary switches :
 - Switch-fuse-disconnector position 2NO+2NC
 - Earthing switch position 2NO+2NC
 - Fuse blown 1 NO
- Capacitive voltage indicator
 - VPIS acc. to IEC 61958 with integrated indicator lamps (LED)
- Ronis key interlock on earthing switch

Technical data

Switch-fuse disconnecter

Rated voltage	kV	36	38.5	40.5 ^{*)}
Power frequency withstand voltage	kV	70	80	95
- Across disconnecter	kV	80	95	118
Lightning impulse withstand voltage	kV	170	180	185
- Across disconnecter	kV	195	210	215
Rated normal current	A	see ¹⁾	see ¹⁾	see ¹⁾
Breaking capacities:				
- Active load	A			
- Closed loop	A			
- Off load cable charging	A			
- Earth fault	A			
- Earth fault cable charging	A			
- Transfer current	kA	840	750	750
Making capacity		see ²⁾	see ²⁾	see ²⁾
Internal arc classification IAC	kA	20	20	20
AFL, 1 sec				
Number of mechanical operations		1000 close/open manual		

Upstream earthing switch

Rated voltage	kV	36	38.5	40.5
Power frequency withstand voltage	kV	70	80	95
Lightning impulse withstand voltage	kV	170	180	185
Making capacity	kA	50	50	50
Class (Electrical endurance)		E2	E2	E2
Short time current 1 sec. ^{*)}	kA	20	20	20
Number of mechanical operations		1000 close/open manual		

Downstream earthing switch

Rated voltage	kV	36	38.5	40.5
Power frequency withstand voltage	kV	70	80	95
Lightning impulse withstand voltage	kV	170	180	185
Making capacity	kA	2.5	2.5	2.5
		(5 times)	(5 times)	(5 times)
Class (Electrical endurance)		E2	E2	E2
Short time current 1 sec.	kA	1	1	1
Number of mechanical operations		1000 close/open manual		

^{*)} For 40.5 kV, testing is according to GB standards.

^{**)} Optional 25 kA.

1) Depending on the current rating of the fuse-link.

2) Limited by high voltage fuse-links.

V - Vacuum circuit-breaker

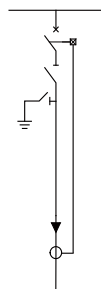

Depth: 900 mm
 Width: 420 mm
 Height: 1930 mm ^{*)}
^{*)} Height with high LV-compartment:
 2180 mm

Standard features

- 630 A vacuum circuit-breaker
- Two position mechanism with auto-reclosing duty for vacuum circuit breaker
- Two position operating mechanisms for the downstream disconnector and earthing switch
- Interlocking between vacuum circuit-breaker and disconnector
- Switch position indication for vacuum circuit-breaker, disconnector and earthing switch
- Self powered electronic protection relay ABB type REJ603 with ring core CTs on cables
- Trip coil (for relay tripping)
- Cable bushings horizontal in front, Interface C (400 series bolted) with integrated capacitor for voltage indication
- Cable compartment cover allowing double cable connection
- Main busbar, 630 A
- Earthing bar

Factory assembled options

- Bushings for connection of external busbars or cable on
 - Interface 2 (inside cone)
 - Interface C (400 series bolted)
- Interlocking
- Cable compartment front cover interlocked with earthing switch
- Signal (1NO) from internal pressure indicator wired to terminals (only one each SF₆ tank)

Additional equipment also available as retrofit

- Manometer
- Motor operation for vacuum circuit-breaker
- High LV-compartment with hinged door
- Short circuit indicator

Auxiliary switches

- Vacuum circuit-breaker position 2NO+2NC
- Disconnector position 2NO+2NC
- Earthing switch position 2NO+2NC
- Vacuum circuit-breaker tripped signal 1NO

Technical data

Vacuum circuit-breaker

Rated voltage	kV	36	38.5	40.5 ^{*)}
Power frequency withstand voltage	kV	70	80	95
Lightning impulse withstand voltage	kV	170	180	185
Rated normal current	A	630	630	630
Breaking capacities:				
- Short circuit breaking current (Class E1, S1)	kV	20	20	20
- D.C. component	%	41		<20
- Cable charging breaking current (Class C1)	A	50	50	50
Making capacity	kA	50	50	50
Short time current 1 sec. 1)	kA	20	20	20
Short time current 3 sec.	kA	20	20	20
Internal arc classification IAC AFL, 1 sec	kA	20	20	20
Rated operating sequence	O-0.3 s-CO-3 min-CO			
Number of mechanical operations	1000 (Class M2)			

Downstream disconnector and earthing switch

Rated voltage	kV	36	38.5	40.5
Power frequency withstand voltage	kV	70	80	95
- Across disconnector	kV	80	95	118
Lightning impulse withstand voltage	kV	170	180	185
- Across disconnector		195	210	215
Making capacity	kV	50	50	50
Class (Electrical endurance)		E2	E2	E2
Short time current 1 sec.	kA	20	20	20
Internal arc classification IAC AFL, 1 sec	kA	20	20	20
Number of mechanical operations	2000 close/open manual operations			

^{*)} For 40,5 kV, testing is according to GB standards.

1) Optional 25 kA.

- Capacitive voltage indicating systems
 - VPIS (Voltage Presence Indicating System, acc. to IEC 61958) with integrated indicator lamps
- Trip coil open
- Trip coil open and close
- Undervoltage release (optional electronic time delay device)
- Cable compartment cover
- With extra depth (surge arrestor)
- Arc proof (if existing modules have interlocked covers)
- Ronis key interlock on disconnect/earthing switch

Relays with auxiliary voltage

REF 611 (integrated LV-compartment with hinged door)

REF 615 (integrated LV-compartment with hinged door)

D - Direct cable connection

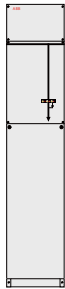

Depth: 900 mm
Width: 420 mm
Height: 1930 mm ^{*)}

^{*)} Height with high LV-compartment:
2180 mm

Technical data

Direct cable connection

Rated voltage	kV	36	38.5	40.5 ^{*)}
Power frequency withstand voltage	kV	70	80	95
Impulse withstand voltage	kV	170	180	185
Rated normal current	A	630	630	630
Short time current 1 sec.	kA	20	20	20
Short time current 3 sec.	kA	20	20	20

^{*)} For 40.5 kV, testing is according to GB standards.

Standard features

- Cable bushings horizontal in front, Interface C (400 series bolted) with integrated capacitor for voltage indication
- Busbar, 630 A
- Earthing bar

Factory assembled options

- Bushings for connection of external busbars on side of the unit
- Signal (1NO) from internal pressure indicator wired to terminals (only one each SF₆-tank)

Optional features also available as retrofit

- Low voltage compartment
- Capacitive voltage indicating systems
 - VPIS (Voltage Presence Indicating System, acc. to IEC 61958) with integrated indicator lamps
- Short circuit and earth fault indicator EKL1
- External current sensors (CT) for monitoring
- Cable compartment cover
 - With extra depth (double cable, surge arresters)
 - Arc proof (if existing modules have interlocked cable compartment)

De - Direct cable connection with earthing switch

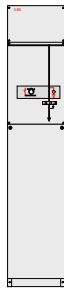

Depth: 900 mm
Width: 420 mm
Height: 1930 mm ^{*)}

^{*)} Height with high LV-compartment:
2180 mm

Standard features

- Earthing switch
- Two-position single spring mechanism
- Switch position indication
- Cable bushings horizontal in front, Interface C (400 series bolted) with integrated capacitor for voltage indication
- Busbar, 630 A
- Earthing bar

Factory assembled options

- Bushings for connection of external busbars on side of the unit
- Interlocking
 - Cable compartment front cover interlocked with earthing switch
- Signal (1NO) from internal pressure indicator wired to terminals (only one each SF₆-tank)

Technical data

Direct cable connection

Rated voltage	kV	36	38.5	40.5 ^{*)}
Power frequency withstand voltage	kV	70	80	95
Impulse withstand voltage	kV	170	180	185
Rated normal current	A	630	630	630
Making capacity	kA	50	50	50
Short time current 1 sec.	kA	20	20	20
Short time current 3 sec.	kA	20	20	20
Number of mechanical operations		1000 close/open manual		

^{*)} For 40.5 kV, testing is according to GB standards.

Optional features also available as retrofit

- Low voltage compartment
- Capacitive voltage indicating systems
 - VPIS (Voltage Presence Indicating System, acc. to IEC 61958) with integrated indicator lamps
- Short circuit and earth fault indicator EKL1
- External current sensors (CT) for monitoring
- Cable compartment cover
 - With extra depth (double cable, surge arresters)
 - Arc proof (if existing modules have interlocked cable compartment)
- Auxiliary switches
 - Earthing switch position 2NO+2NC

M - Metering module

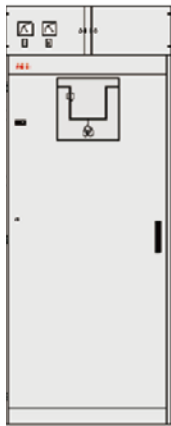

Depth: 1310 mm
Width: 1100 mm
Height: 2180 mm *)

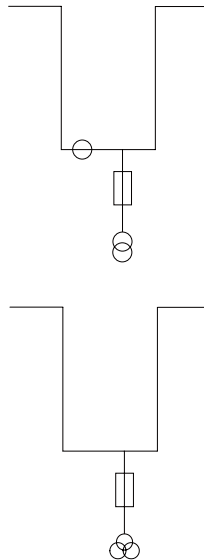

Technical data

Metering module

Rated voltage	kV	36	38.5	40.5 *)
Power frequency withstand voltage	kV	70	80	95
Impulse withstand voltage	kV	170	180	185
Rated normal current	A	630	630	630
Short time current 1 sec.	kA	20	20	20

*) For 40.5 kV, testing is according to GB standards.

Standard features

- M module
 - 2 CTs and 2 VTs
 - Fuse for VTs
 - Low voltage compartment (include current meter and voltage meter each 1pc)
 - Capacitive voltage indicator
- PT module
 - 3VTs
 - Fuse for VTs
 - Low voltage compartment (include voltage meter 1 pc)
 - MWK type arrester

*Required more information connect us.

Outer assembly

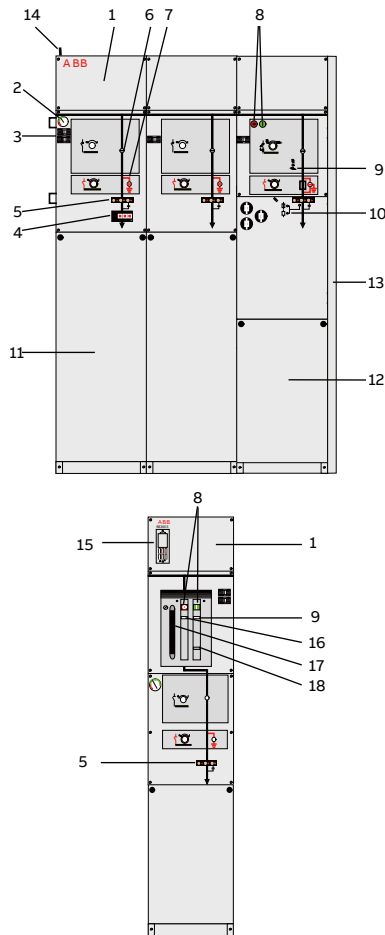

1. Low voltage compartment
2. Manometer
3. Nameplate
4. Short circuit indicator
5. Capacitive voltage indication
6. Load break switch position
7. Earthing switch position
8. Push buttons close/open operation
9. Charged spring indicator
10. Fuse blown indicator
11. Cable compartment cover standard C-module
12. Cable compartment cover standard F-module
13. Side cover
14. Lifting lug
15. Protection relay
16. Position indicator vacuum circuit-breaker
17. Operating mechanism for vacuum circuit-breaker
18. Counter

Covers

Upper and lower front covers are manufactured of 2 millimeter aluzinc and covered with a polycarbonate foil. These foils contain the mimic diagram of the main circuit with the position indicators for the switching devices.

Background colour for these foils is grey RAL 7035, which makes the black single line diagram to stand out for easy optical reading of position indicators. Both the upper and lower front covers are removable.

Low voltage compartments are available in three different versions: integrated without hinged door, integrated with hinged door and high with hinged door. For the high version, total height of panel will be 2180 mm.

There are three different cable compartment covers; standard, arc proof and one with extra depth for parallel cables. All cable compartment covers are removable. Each module has a separate cable compartment which is divided from the others by means of partition walls.

A vertical partition wall is fitted to divide the cable compartment(s) from the rear side of the switchgear/ring main unit. In case of an internal arc fault, followed by an opening of the pressure relief in the bottom of the tank, this partition wall will prevent the hot gases blowing out from the pressure relief to enter the cable compartments.

Side covers are made of 1.5 mm millimeter hot rolled steel and powder painted in colour RAL 7035.

Cable switch module

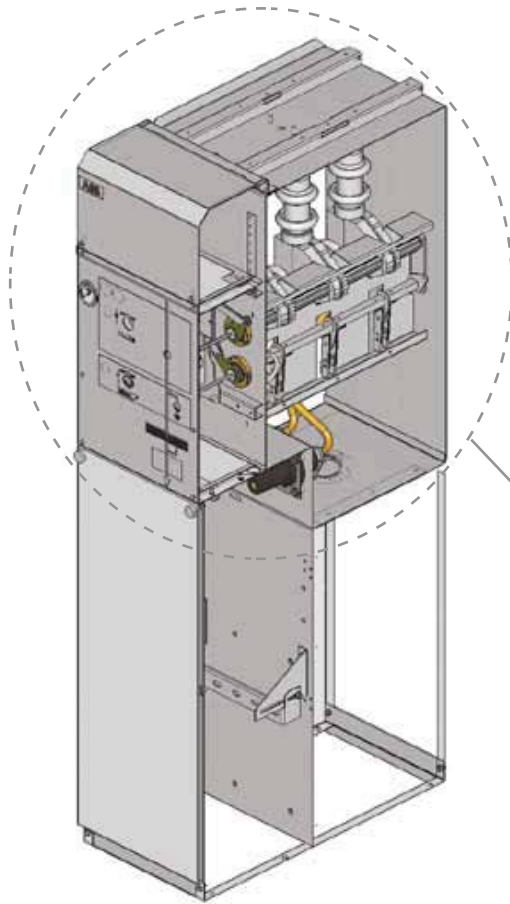

The cable switch (C-Module) is a two positioning switch-disconnector using SF₆ gas as an arc quenching medium with a separate earthing switch.

The switch positions are close and open. In the open position the switch satisfies the disconnector requirements.

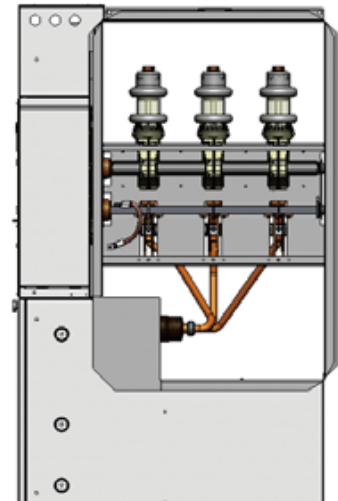

Switch-fuse module

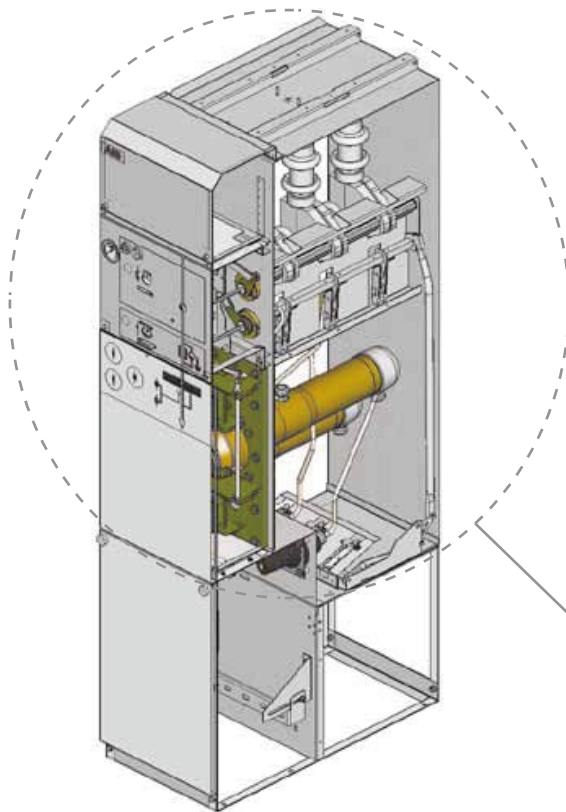

The switch-fuse combination (F-Module) is a two positioning switch disconnecter with a separate earthing switch.

By means of the fuse tripping device it operates as a switchfuse combination. There is a double earthing switch which in the earthed position connects earth to both sides of the fuses simultaneously.

Both earthing switches are operated in one operation. The switch-fuse and earthing switch is mechanically interlocked to prevent hazardous access to the fuses.

The lower cover which gives access to the fuses is also mechanically interlocked with the earthing switch.

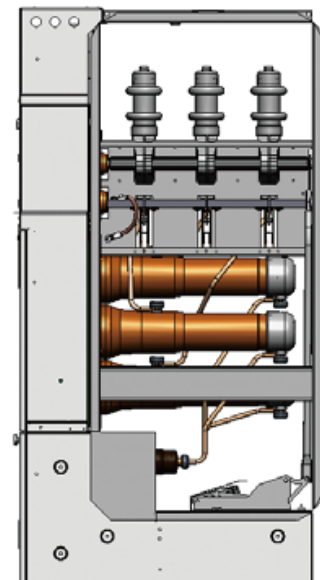

Vacuum circuit-breaker module

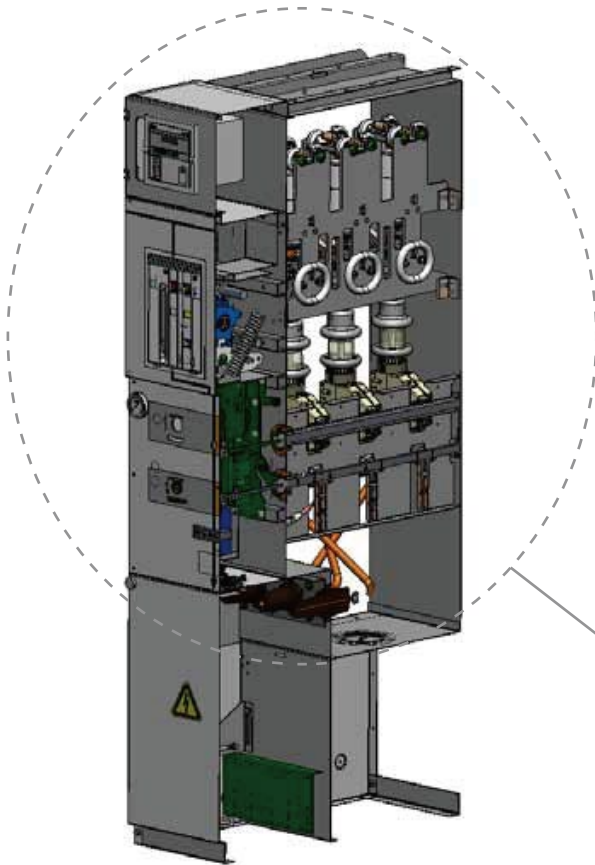

The vacuum circuit-breaker (V-module) has vacuum bottles for short-circuit current interruption.

A two-position disconnector is connected in series with the circuit-breaker. After the disconnector has been opened the integrated down-stream earthing switch can be closed.

The operation between vacuum circuit-breaker and disconnector as well as between disconnector and earthing switch are mechanically interlocked.

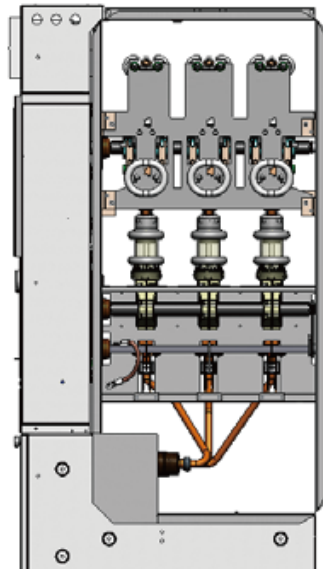

Cable bushings

—
01 400 series
bushing (interface
C) with terminal for
capacitive voltage
indication
—

02 Inner cone
(interface 2)
bushing for
connection of
external busbars (or
cable) on the side of
the unit
—



—
01

The connection of the HV-cable is made by cable bushings. The bushings are made of cast resin with moulded in conductors.

In addition, a screen is moulded in to control the electrical field and is also used as the main capacitor supplying the voltage indicators.

ABB has produced bushings for SF₆ switchgears since 1985 with high performance and quality.

A very large number has been installed worldwide in distribution networks, power stations and industrial complexes.

Used together with fully screened connectors it is an ideal solution for areas with humidity or condensation problems. The bushings are designed according to EN 50180/EN 50181.



—
02

Completely sealed enclosure

SafeRing/SafePlus 36 are switchgear types using SF₆ gas (sulfur hexafluoride) as insulation and quenching medium. The SF₆ is contained in a welded stainless steel enclosure.

The pressure system is defined as a sealed for life system with an operating life time better than 30 years. The leakage rate is less than 0.1% per year.

In order to guarantee a reliable and tight welding, all welding is carried out by computer controlled robots.

Electrical and mechanical bushings are clamped to the enclosure and sealed by high quality O-rings.

The mechanical bushings have in addition a rotating shaft which connect the shaft of the switch to the corresponding shaft of the mechanism.

The rotating shaft is sealed by a double set of gas seals.

All SF₆ enclosures have to pass the leakage test with Helium, before being gas filled with SF₆.

Due to the characteristics of Helium, this test will detect any leakage. Leakage test and gas filling are made inside a vacuum chamber.

The SF₆ enclosure has a degree of protection of IP67. This means the SF₆ enclosure can be immersed into water and still maintain all functions in a satisfactory way.



Mechanisms and interlocks

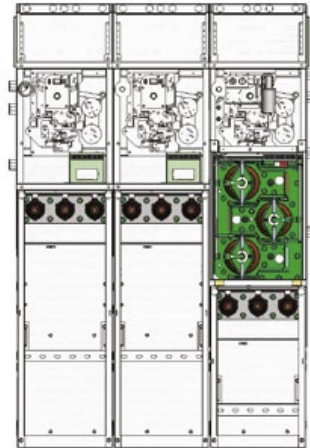

All operating mechanisms are situated outside the SF₆ - enclosure behind the front covers with degree of protection of IP2X.

This gives the opportunity of easy access to all operating mechanisms if retrofit or service should be required. The speed of operation of these mechanisms is independent of how fast the handle is operated.

As an option, all units can be equipped with interlocked cable covers. This will prevent access to the cable compartment before earthing switch is in closed position. It will also be impossible to operate switch disconnector to closed position before cable compartment cover is put back in place.

Each mechanism is equipped with a padlocking device. When adding a padlock to this device, the access to operate the mechanism will be prevented. This device has three holes with diameter 9 millimeter.

All operating mechanisms are equipped with true position indicators for all switches. In order to safeguard true indication, indicators are directly connected to the operating shafts of the switches inside the SF₆ tank.

Operating handle has an anti-reflex system which prevents an immediate re-operation of the switch.

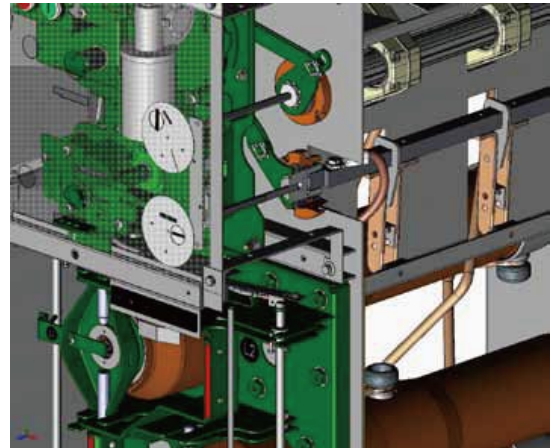

All steel parts have been electroplated with zinc and passivated against corrosion.

Switch-fuse module (F)

The mechanism (3PAE) has two operating shafts; the upper one for the load break switch and the lower one for the earthing switch.

The upper one operates two springs; one for closing and one for opening. Both springs are charged simultaneously. By means of mechanical push buttons it is then possible to close and open the load break switch.

The opening spring is always charged when the load break switch is in closed position and will then be ready to open the load break switch immediately if one of the HV fuses blows.

The blown fuse(s) has/have to be replaced before the operator will be able to close the load break switch again. According to IEC Publ. 60282-1, all three fuse-links should be replaced, even if only one or two have operated.

The lower shaft is single spring operated. Both operating shafts operate one common shaft which is directly connected to the load break switch and earthing switch inside the SF₆ enclosure.

Due to the mechanical interlock between the upper and lower operating shaft, it is impossible to operate the load break switch when earthing switch is in earthed position or operate the earthing switch when the load break switch is in closed position.

It will also be impossible to get access to the fuse compartment before earthing switch is in closed position.

Cable-switch module (C)

The mechanism (3PKE) has two operating shafts; the upper one for the load break switch and the lower one for the earthing switch.

Both shafts are single spring operated and they are directly connected to the switches inside the SF₆ enclosure. When both load break switch and earthing switch are in open position the switch satisfies the specifications of disconnecter.

Due to the mechanical interlock between the upper and lower operating shaft, it is impossible to operate the load break switch when earthing switch is in earthed position or operate the earthing switch when the load break switch is in closed position.

Vacuum circuit-breaker (V)

This module has two mechanisms; the upper one (EL) is for circuit-breaker and the lower one (3PKE) with two operating shafts is for disconnecter and earthing switch. The vacuum circuit-breaker has the possibility of rapid auto-reclosing duty. By means for mechanical push buttons it is possible to close and open the circuit-breaker. The opening spring is always charged when the circuit-breaker is in closed position and will be ready to open immediately if the protection relay gives a trip signal. If the mechanism is recharged after closing, it is possible to perform open - close - open sequence.

The lower mechanism is identical to the one described above for cable switch module.

There is a mechanical interlock between these two mechanisms which prevents operating of the disconnecter and earthing switch when the circuit-breaker is in closed position.

When the earthing switch is in closed position it will be impossible to operate the disconnecter, but the circuitbreaker can be closed for testing purpose.

Side extension

01 SafePlus 36 with a fully modular design

02 SafePlus 36 consisting of three sections (FFF+C+C) connected to each other by means of side extension kit

03 The installation of the external busbars has to be done on site, see separate installation instructions, 1VDD006146 GB.

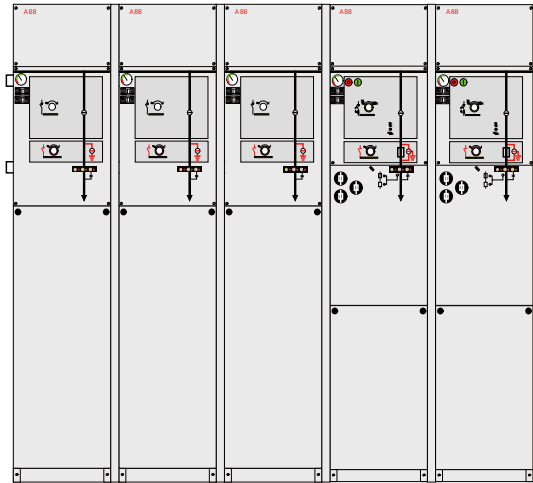

01

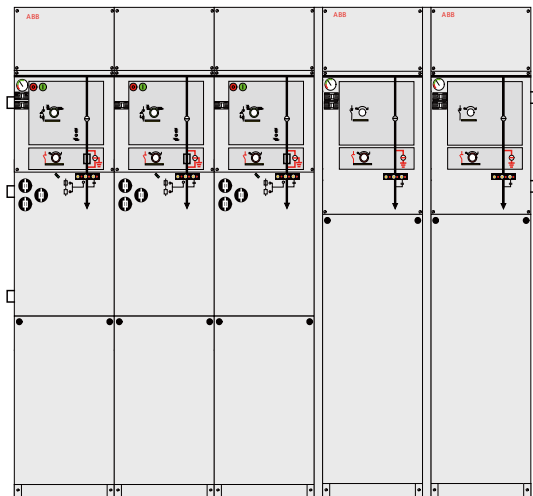

02

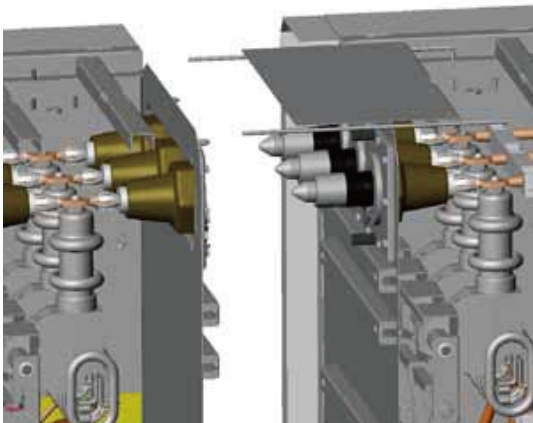

03

As an option, SafeRing/SafePlus 36 can be provided with bushings for side extension on one or both sides.

For a SafePlus 36 switchgear consisting of only one module, bushings on both sides are necessary if future extension is required.

When bushings are mounted on the side, you will have these possibilities using our side extension kit:

1. SafePlus switchgear as fully modular.
2. SafePlus switchgear as semimodular.

As 4-way switchgear is the maximum size within one common SF₆-tank, the busbar kit allows a configuration with more than 4 modules.

For practical handling of modules on site, the switchgear can be extended by 1-way units only.

Low voltage compartment

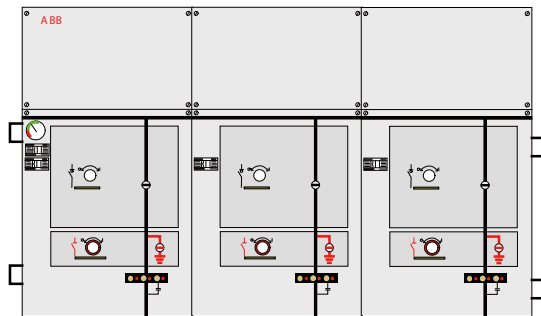

When motor operation, coils, auxiliary switches or other relevant components are mounted on a SafeRing/SafePlus 36 module, the auxiliary relays, MCB/fuses and terminals are located in the LV compartment on the top.

The LV compartment allows entrance of the customer's low voltage cables from the rear side, left and right side at the top of the switchgear. Also, the LV compartment gives the opportunity to install A-meters with selector switch and local/remote switch for motor operation.

As an option the standard LV-compartment can be delivered with hinged door.

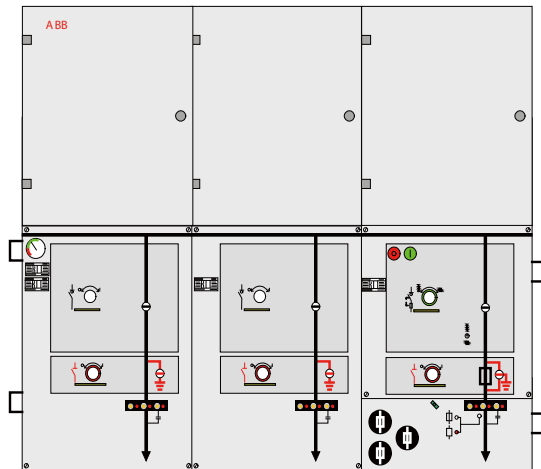

Additionally all SafePlus switchgear can be supplied with a high LV compartment. This compartment can be equipped with protection relay, meters, terminal blocks etc.

Motor operation and coils

Closing and opening operations of load-break switches and charging of the springs of the mechanism for the switch-fuse combination can be performed with a motor operation. Earthing switches do not have this possibility.

All motor devices require DC voltage. If control voltage is either 110 or 220 VAC, a rectifier is integrated in the control unit.

Operating cycle for motor operation for C- and F-module is CO - 3 min (i.e. it can be operated with a frequency of up to one close and one open operation every third minute). Operating sequence for V-module is O-0.3 s-CO-3 min-CO.

Test voltage for tables below is +10/- 15% for motor operations and closing coils and +10/-30% for trip coils and opening coils.

Motor and coils can easily be mounted on the mechanisms after delivery (retrofit).

Characteristics of motor operation for C-module

Rated voltage (V)	Power consumption [W] or [VA]	Operating times		Peak start current (A)	Fuse
		Closing time (s)	Opening time (s)		
24	130	6-10	6-10	19	F8 A
48	150	4-7	4-7	13	F4 A
60	90	6-9	6-9	7	F4 A
110	90	6-9	6-9	3	F2 A
220	90	6-9	6-9	1.7	F1 A

Characteristics of motor operation for F-module

Rated voltage (V)	Power consumption [W] or [VA]	Operating times		Peak start current (A)	Fuse
		Charge/Closing time (s)	Opening time (ms)		
24	180	8-15	40-60	19	F8 A
48	200	5-9	40-60	13	F4 A
60	140	8-13	40-60	7	F4 A
110	140	8-13	40-60	3	F2 A
220	140	8-13	40-60	1.7	F1 A

Characteristics of motor operation for V-module

Rated voltage (V)	Power consumption [W] or [VA]	Charge time (s)	Current (A)	Peak start current (A)	Fuse
24	150	4-9	6.4	22	F8 A
48	150	4-9	3.2	11	F4 A
60	150	4-9	3.2	11	F4 A
110	150	4-9	1.4	7.1	F2 A
220	150	4-9	0.7	3.2	F1 A

—
Characteristics of shunt trip coils, closing coils and opening coils F-module

Rated voltage (V)	Power consumption [W] or [VA]	Operating times		Current (A)	Fuse
		Closing time (ms)	Opening time (ms)		
24 V DC	170	40-60	40-60	7	F8 A
48 V DC	200	40-60	40-60	4	F4 A
60 V DC	200	40-60	40-60	3	F4 A
110 V DC	200	40-60	40-60	2	F2 A
220 V DC	200	40-60	40-60	1	F1 A
110 V DC	200	40-60	40-60	2	F2 A
220 V DC	200	40-60	40-60	1	F1 A

—
Characteristics of shunt trip coils, closing coils and opening coils V-module

Rated voltage (V)	Power consumption [W] or [VA]	Operating times		Current (A)	Fuse
		Closing time (ms)	Opening time (ms)		
24 V DC	170	40-60	40-60	7	F8 A
48 V DC	200	40-60	40-60	4	F4 A
60 V DC	200	40-60	40-60	3	F4 A
110 V DC	200	40-60	40-60	2	F2 A
220 V DC	200	40-60	40-60	1	F1 A
110 V DC	200	40-60	40-60	2	F2 A
220 V DC	200	40-60	40-60	1	F1 A



Auxiliaries like motor drives, operation coils and auxiliary switches are all located behind the upper front covers.

Electrical control unit for motor-operation and the internal wiring in general, are terminated to the terminals located in the low voltage compartments.

Transformer protection

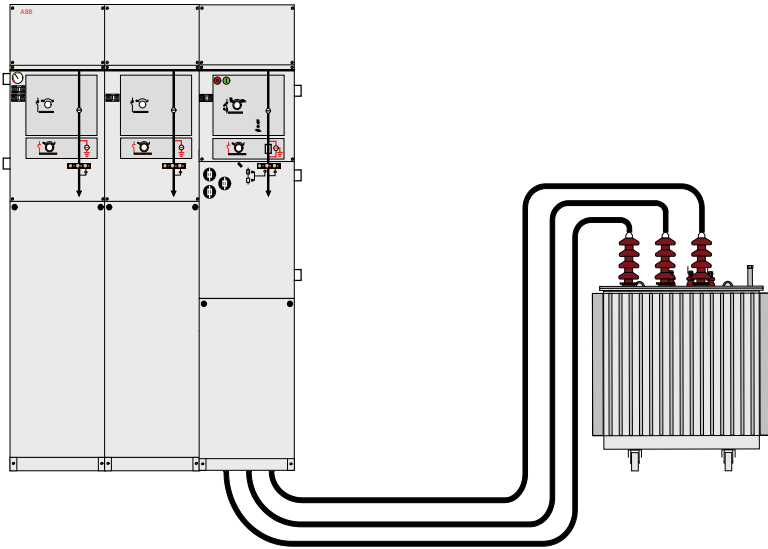

SafeRing/SafePlus 36 offer a choice between switch-fuse combination or circuit-breaker in combination with relay for transformer protection.

The switch-fuse combination offers optimal protection against short-circuit currents, while the circuit-breaker with relay offers better protection against low over-currents. Circuitbreaker with relay is always recommended for higher rated transformers.

SafeRing and SafePlus V-module are delivered with 630A rating. Both for SafeRing and SafePlus the relay is self powered utilizing the energy from the CT's under a fault situation, for energizing the trip coil.

The self powered relay can also be used for cable protection and more details on the different relays can be found in chapter 6.6.

Transformer protection with self powered relay

- ABB relay type REJ 603

Important features V-module

- Relay behind cover. No need for additional low voltage box for the self powered relays used for transformer protection

Typical for vacuum circuit-breaker protection

- Good protection against short-circuits
- Very good for protection of over-currents
- Small fault currents are detected in an early stage

SafeRing/SafePlus 36 - Fuse-link selection

By selection of fuse-links for the protection of a transformer, it is important that requirements in IEC 62271-105 and in IEC 60787 are fulfilled. In particular Annex A in IEC 62271-105 gives a good example of the coordination of fuses, switch and transformer.

Correct selection of fuse-links for the protection of the transformer will give:

- Optimal protection of the transformer
- No damage on the fuse-link's fuse-elements due to the magnetizing inrush current of the transformer
- No overheating of the fuse-links, the switch-fuse combination or the switchgear due to the full load current or the permissible periodic overload current of the transformer
- A transfer current of the combination which is as low as possible, and less than the rated transfer current of the switch-fuse combination
- A situation where the fuse-links alone will deal with the condition of a short-circuit on the transformer secondary terminals
- Fuse-links that discriminate with the low-voltage fuse-links in the event of phase-to-phase faults occurring down stream the low-voltage fuse-links

By carefully checking that these rules are followed, fuse-links from any manufacturer can be used in combination with SafeRing/SafePlus 36 as long as the fuse-links are in accordance with the requirements described on page 35.

Fuse selection table - CEF

SafeRing 36		Rated voltage:	36 kV	Rated voltage:	40.5 kV
SafePlus 36		Operating voltage:	30 kV	Operating voltage:	35 kV
F-panel		I_{transfer} at 36 kV:	840 A	I_{transfer} at 40.5 kV:	750 A
100% load		T_o:	40 ms	T_o:	40 ms
Transformer rating (kVA)	u_k (%)	ABB Catalogue no.	Fuse link rated current (A)	ABB Catalogue no.	Fuse link rated current (A)
100	4	1YMB744014M5611	6.3	1YMB744014M5611	6.3
125	4	1YMB744016M5611	10	1YMB744014M5611	6.3
160	4	1YMB744016M5611	10	1YMB744016M5611	10
200	4	1YMB744018M5611	16	1YMB744016M5611	10
250	4	1YMB744018M5611	16	1YMB744016M5611	10
315	4	1YMB744018M5611	16	1YMB744018M5611	16
400	4	1YMB744018M5611	16	1YMB744018M5611	16
500	4	1YMB744021M5611	25	1YMB744019M5611	20
630	4	1YMB744021M5611	25	1YMB744019M5611	20
800	5	1YMB744021M5611	25	1YMB744021M5611	25
1000	6	1YMB744025M5811	40	1YMB744024M5611	31.5
1250	6	1YMB744025M5811	40	1YMB744025M5811	40

SafeRing 36		Rated voltage:	36 kV	Rated voltage:	40.5 kV
SafePlus 36		Operating voltage:	30 kV	Operating voltage:	35 kV
F-panel		I_{transfer} at 36 kV:	840 A	I_{transfer} at 40.5 kV:	750 A
120% load		T_o:	40 ms	T_o:	40 ms
Transformer rating (kVA)	u_k (%)	ABB Catalogue no.	Fuse link rated current (A)	ABB Catalogue no.	Fuse link rated current (A)
100	4	1YMB744014M5611	6.3	1YMB744014M5611	6.3
125	4	1YMB744016M5611	10	1YMB744014M5611	6.3
160	4	1YMB744016M5611	10	1YMB744016M5611	10
200	4	1YMB744018M5611	16	1YMB744016M5611	10
250	4	1YMB744018M5611	16	1YMB744016M5611	10
315	4	1YMB744018M5611	16	1YMB744018M5611	16
400	4	1YMB744018M5611	16	1YMB744018M5611	16
500	4	1YMB744021M5611	25	1YMB744019M5611	20
630	4	1YMB744021M5611	25	1YMB744021M5611	25
800	5	1YMB744025M5611	40	1YMB744021M5611	25
1000	6	1YMB744025M5811	40	1YMB744025M5811	40
1250	6	1YMB744025M5811	40	1YMB744027M5811	50

- Both tables above are based on using ABB CEF high-voltage current-limiting back-up fuse-links
- Normal operating conditions with no overload of transformer (table 1) and with 20% overload of transformer (table 2)
- Ambient air temperature -25°C to +40°C

Fuses

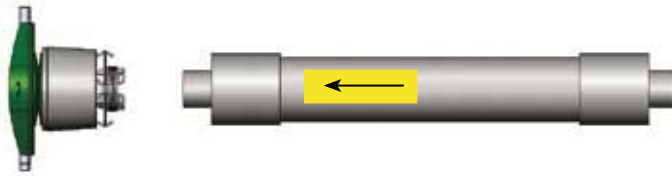

SafeRing/SafePlus 36 are designed and tested for HRC-fuses acc. to IEC Publication 60282-1.

The dimensions of the fuse-links that can be used in SafeRing/SafePlus 36 must be in accordance with IEC 60282-1, Annex D. The fuse-links have to be type I with terminal diameter ($\varnothing A$) equal to 45 +1 mm and body length (D) equal til 537 +1 mm.

The dimensions of the fuse-links can also be in accordance with DIN 43 625 and the length of the fuse canister is based on the use of fuse-links with length 537 mm.

SafeRing/SafePlus 36 are designed for fuse-links with striker in accordance with IEC 60282-1. The striker must be type "Medium" with an energy of 1 J and a travel of minimum 20 mm. The start force of the striker should be minimum 60 N.

Please note: When inserting the fuse link into the canister, the striker-pin must always face outwards against the fuse holder.

2100 kVA is the maximum size distribution transformer which can be fed from a SafeRing/SafePlus 36 fuse switch module.

The previous table shows recommended types of fuse links for use in SafeRing/SafePlus 36.

In order to find the correct fuse size compared to the transformer rating in kVA, please see the selection tables on previous pages.

Relays

The V-module for SafePlus 36 kV is available with 630 A vacuum circuit-breaker. This chapter describes the different choices of protection relays and feeder terminals that can be used in SafePlus. Some of these relays require an additional low voltage compartment.

Standard test procedure is functional test of trip circuit of the relays. All customer settings must be done on site.

ABB feeder terminals are configured according to customer specification for protection functions. Special control requirements can be delivered on request.

The V-module can also be delivered prepared for protection relays.

This is defined in two types:

1. Trip coil and auxiliary contact.
2. Cut out in LV-compartment, trip coil, aux contact, wiring and drawings.

This is applicable for relays delivered complete from our factory or if we have received necessary documentation on the relay.

Other types of relays on request.

There are three main groups of relays delivered:

- A) ABB feeder protection relays
 - B) Self powered relays
 - C) ABB feeder terminals
- A) ABB offers a wide range of feeder protection relays. These relays have been sold for a long period and have an excellent reputation for reliability and secure operation. These relays have either 18-80VDC or 80-265VAC/DC auxiliary supplies and are connected to conventional CTs and VTs.
- B) Self powered relays are suitable for rough conditions and places without possibility of auxiliary supply. SafeRing and SafePlus can be delivered with ABB REJ603 to fulfil all relevant needs in a distribution network.
- C) ABB feeder terminals provide cost-effective solutions for different protection, monitoring and control applications. SafePlus can be delivered with REF 615.



—
ABB feeder protection relays

Protection and measurement

Type of faults	IEEE device no.	IEC symbol	Protection function	Relay REF 615
Short circuits	51 50/51/51B	3 I >	Non-directional overcurrent, low-set stage	X
Short circuits	50/51B	3 I >>	Non-directional overcurrent, high-set stage	X
Short circuits	51	3 I >>>	Non-directional overcurrent instantaneous stage/blockable	X
Short circuits	50/51	2 I >	Two-phase non-directional overcurrent, low-set stage	
Short circuits	51N	2 I >>	Two-phase non-directional overcurrent, high-set stage	
Earth fault	51N	Io >	Non-directional earth fault, low-set stage	X
Earth fault	50N/51N	Io >/SEF	Non-directional earth fault, low-set stage	
Earth fault	67N	Io >>/Io-o>	sensitiveNon-directional earth fault, high-set stage	X
Earth fault	67N	Io >>>/SEF	Directional earth fault, sensitive, In=1 A and 5 A	X
Earth fault	67N	Io >>>/SEF	Directional earth fault, sensitive, In=0.2 A and 1 A	
Earth fault	59N	Io >> -->	Directional earth fault, high-set stage	X
Earth fault	46	Uo >	Residual overvoltage	X
Additional functions	62BF	Δ I >	Phase discontinuity	X
Additional functions		CBFP	Circuit-breaker failure	X
Type of measurements current		3I/2I	Three-phase/two-phase current	X
Type of measurements current		Io	Neutral current	X
Type of measurements current		Δ I	Degree of unbalance	
Type of measurements current		Uo	Residual voltage	X
Auto-reclosing	79			X

—
ABB self-powered relays

Functionality	Description	IEEE device no.	Relay REJ 603
Protection functions	Phase overcurrent (multi-characteristic)	50/51	X
Protection functions	Short-circuit protection	50/51	X
Protection functions	Number of overcurrent elements	50/51B	2
Protection functions	Earth fault current	50N/51N	X
Protection functions	Number of earth fault elements		2
Characteristic curves	Overcurrent element		DEFT, INV ¹⁾
Characteristic curves	Earth fault current		DEFT, INV ¹⁾
Additional functions	Trip indication		X
Additional functions	Electro-impulse		X
Additional functions	Input remote tripping (voltage)		X
Additional functions	Auxiliary power, voltage (option)		
Measuring circuit	Rated secondary current		wide range special CT
Measuring circuit	Measuring range, start current I> (A)		7.2
Climatic withstand	Storage temperature (°C)		-40 ...+85
Climatic withstand	Operating temperature (°C)		-40 ...+85

1) - Definite time overcurrent (DEFT)
 - Normal inverse time overcurrent (NINV)
 - Very inverse time overcurrent (VINV)
 - Extremely inverse time overcurrent (EINV)
 - Long time inverse time overcurrent (LINV)

- Resistance inverse timeovercurrent (RINV)
 - Characteristics of high voltage fuse-link (HV-FUSE)
 - Characteristics of full range fuse (FR-FUSE)
 - Definite time overcurrent
 - Inverse characteristics, please contact us for further information

REJ603 transformer protection and cable protection kit (self powered)	Ring core current transformer type	Current range
Transformer type	CT1	8 - 28 A
Transformer type	CT2	16 - 56 A
Transformer type	CT3	32 - 112 A
Transformer type	CT4	64 - 224 A
Transformer type	CT5	128 - 448 A

Combisensor

Technical data general	up to 630 A	
Rated primary current of application	up to 40.5 kV	
Rated primary voltage of application	KEVCY 36 RE1	36 kV
Highest voltage for equipment, U _m	KEVCY 40.5 RE1	40.5 kV
Rated power frequency withstand voltage	KEVCY 36 RE1	70 kV
	KEVCY 40.5 RE1	95 kV
Rated lighting impulse withstand voltage	KEVCY 36 RE1	170 kV
	KEVCY 40.5 RE1	185 kV
Technical data, voltage sensor	Value	
Rated primary voltage, U _{pr}	KEVCY 36 RE1	33/√3 kV
	KEVCY 40.5 RE1	35/√3 kV
Maximum rated primary voltage, U _{primax}	KEVCY 36 RE1	36/√3 kV
	KEVCY 40.5 RE1	40.5/√3 kV
Rated frequency, f _n	50/60 Hz	
Accuracy class	0.5/3P	
Rated burden, R _{br}	10 MOhm	
Rated transformation ratio, K _n	10 000 : 1	
Rated voltage factor, k _u	1.9/8 h	
Technical data, current sensor		
Rated primary current, I _{pr}	80 A	
Rated transformation ratio, K _{ra}	80 A/0.150 V at 50 Hz	
	80 A/0.180 V at 60 Hz	
Rated secondary output, U _{sr}	3 mV/Hz	
	i.e 150 mV at 50 Hz	
	or 180 mV at 60 Hz	
Rated continuous thermal current, I _{cth}	630 A	
Rated short-time thermal current, I _{th}	25 kA/3 s	
Rated dynamic current, I _{dyn}	63 kA	
Rated frequency, f _r	50/60 Hz	
Rated extended primary current factor, K _{pcr}	7.875	
Accuracy limit factor, K _{aif}	100	
Rated burden, R _{br}	10 MOhm	
Cables		
Current and voltage sensing:		
Length	2.2 m	
Connector	RJ-45 (CAT-6)	
Coupling electrode:		
Length	0.45 m	
Connector	BNC	

Sensor

variants Combined sensors with type designations KEVCY 36 RE1 and KEVCY 40.5 RE1. One version could be selected for both types of combined sensors which provides current measurement, voltage measurement together with voltage indication capability.

Linearity

Due to the absence of a ferromagnetic core the sensor has a linear response over a very wide primary current range, far exceeding the typical CT range.

Current sensor

Current measurement in KEVCY xx RE1 sensors is based on the Rogowski coil principle. A Rogowski coil is a toroidal coil, without an iron core, placed around the primary conductor in the same way as the secondary winding in a current transformer.

Voltage sensor

Voltage measurement in KEVCY xx RE1 sensors is based on the capacitive divider principle.

Sensor application

KEVCY xx RE1 are compact and very small bushing type sensors designed to be used in SF₆ gas insulated switchgear type SafeRing and SafePlus.

The external cone type of the sensor is designed according to the standard EN 50181, Interface C (400 series 630 A, M16 bolt), and therefore enables connection of all compatible cable plugs.

Secondary cables

The sensor is equipped with two cables:

- Cable for coupling electrode with BNC connector
- Current and voltage signal cable with RJ-45 connector for connection with the IED

The cable connector for connection with the IED is type RJ-45. The sensor accuracy classes are verified up to the RJ-45 connector, i.e. considering also its secondary cable. This cable is intended to be connected directly to the IED, and subsequently neither burden calculation nor secondary wiring is needed. Every sensor is therefore accuracy tested when equipped with its own cable and connector.

Standard cable length for connection with IED:
2.2 m standard cable length for connection with coupling electrode: 0.45 m



Cable terminations

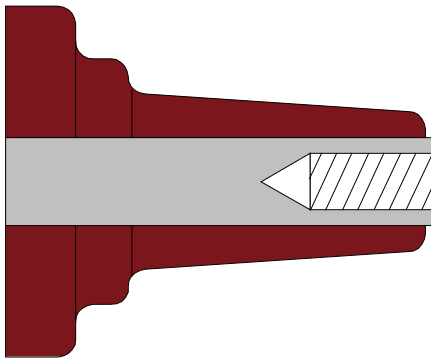

Interface C (bolted type 400 series)

SafeRing/SafePlus 36 are equipped with cable bushings which comply with CENELEC EN 50181 and IEC 60137 for termination of cables.

The bushings fulfil the requirements of DIN47636T1.

The following cable bushings are used:

Interface C with M16 x 2 metric threads
400 series, I_n = 630 A
Standard on all modules and for side connection.

All bushings are protected by cable compartment cover. The drawings below show typical arrangements with cable connectors.

The table below the drawings shows the distance A in millimeter from cable bushing to the inner part of cable compartment cover.

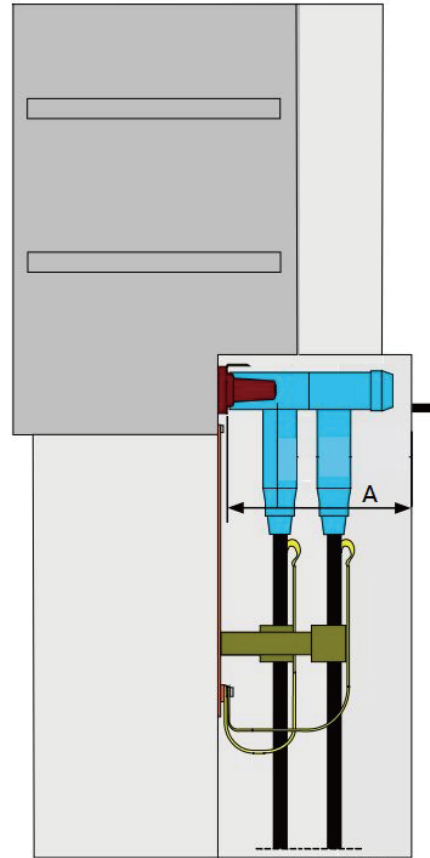
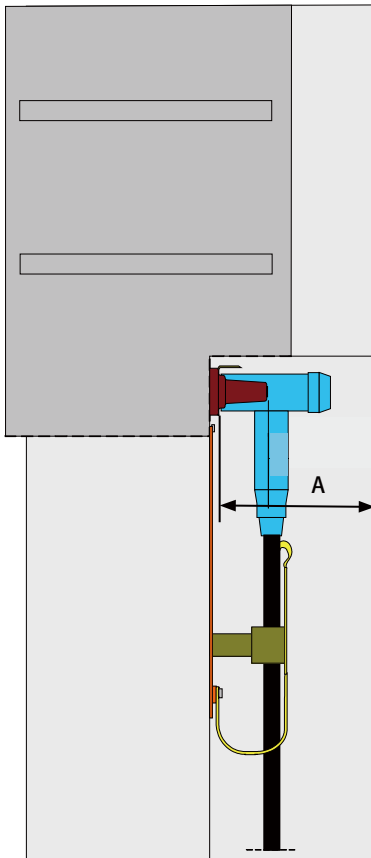

	Distance A
Standard	350 mm
Double cables	390 mm
Arc proof cable covers	331 mm

The following manufacturers of cable terminations are recommended:

- ABB & Nexans

Short-circuit indication and phase comparators



PCM



VPIS



EKL1

Phase comparators type PCM

The PCM-phase comparator indicates phase balance/unbalance between two cubicles. To be used in capacitive Coupling systems, acc. to IEC 61243-5 and/or IEC 61958.

Special features:

- No external power supply required
- Voltage indication by flashing LED
- Fully insulated system (IP 68) with cast resin
- Function test 230 V AC or test-equipment

Technical data:

Rated frequency	50 Hz
Length of test lead	1.4 m
Operating temperature	-25 -+55 degrees celsius
Dimensions, wxhxd, (excl. connectors)	43x22x20 mm
Enclosure protection	IP 68
Weight	40 gr

Voltage presence indicating system

SafeRing/SafePlus 36 are delivered with a voltage Presence Indicating System (VPIS) acc. to IEC 61958.

The coupling system has integrated voltage indicators (LEDs). The VPIS solution is the recommended choice for normal indoor operating conditions.

Earth fault and Short-circuit indicator

When the phase current and zero sequence current is higher than the set value, it will raise an alarm. The LED for short circuit will show on the short-circuit indicator three-phase share main indicator panel. The fault alarm can be sent to remote spot.

Ronis key interlocks

As an option all load break switches and earthing switches may be equipped with Ronis key interlock type EL11AP. Ronis may be mounted according to the customer's specification; either to prevent closing or opening of the switch.

Ronis key interlocks can be used as follows:
Two switchgears A and B are connected to each other by cables. The purpose of interlocks is to prevent closing of the earthing switch unless the load break switch on the other switchgear is locked in open position.

1) One Ronis key interlock will be mounted close to the operating shaft of the load break switch in switchgear A. An identical Ronis key interlock will be mounted close to the operating shaft of the earthing switch in switchgear B. As long as the load break switch in switchgear A is in closed position, it will be impossible to remove or operate the key in the key interlock.

2) First you have to operate this load break switch in switchgear A to open position.

Then it will be possible to operate this key interlock and turn the key which extends the locking bolt. This will prevent the access to the operating shaft of this load break switch. The next thing to do is to withdraw the key and insert it into the identical key interlock on the earthing switch of switchgear B.

3) When the key is inserted, you will be able to operate the key interlock and turn the key which will withdraw the extended locking bolt.

Then you will have access to operate this earthing switch to closed position. As long as this earthing switch is in closed position, the key will be captured and makes it impossible to close the load break switch in switchgear A.

4) If the load break switch in switchgear B and earthing switch in switchgear A are equipped with another identical Ronis key interlock which has a different key combination than described above, it will be impossible to make

an earth connection of an incoming energized cable from neither switchgear A nor B.

Another example for use of Ronis key interlocks is to prevent access to the distribution transformer before the primary side of the the transformer is connected to earth. This can be solved by means of two identical Ronis key interlocks; one mounted on the earthing switch for the distribution transformer feeder and the other one on the door in front of the transformer.

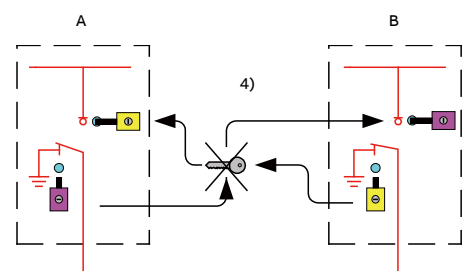
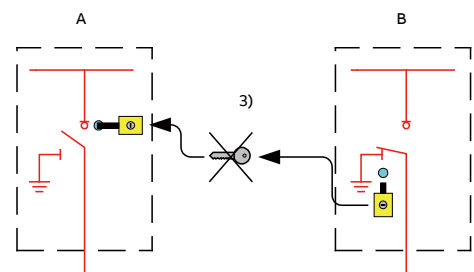
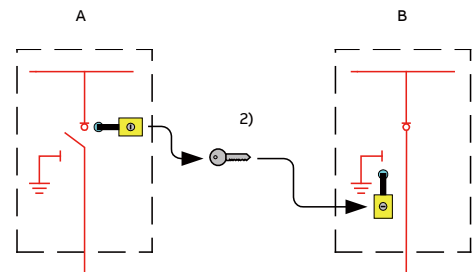
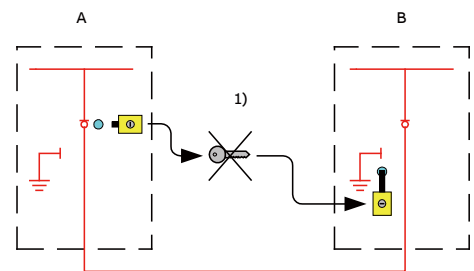

Dimensions

Standard units

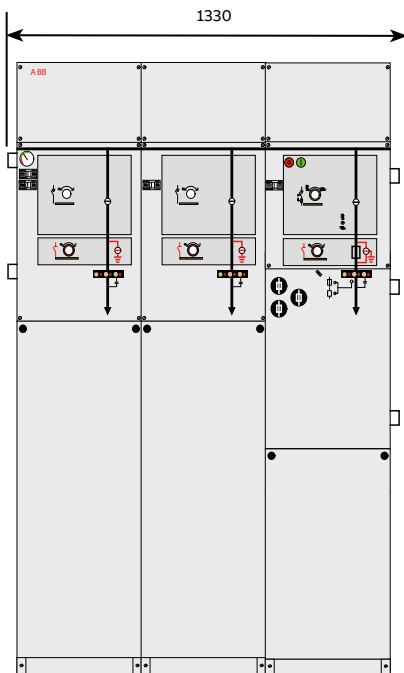
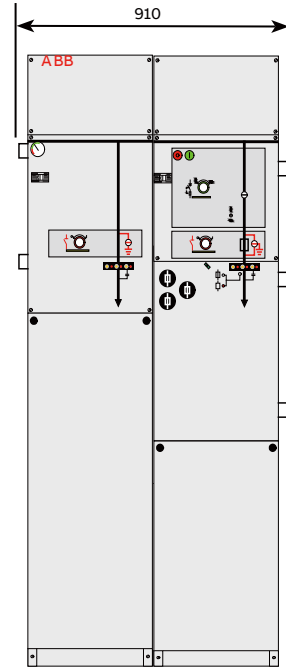
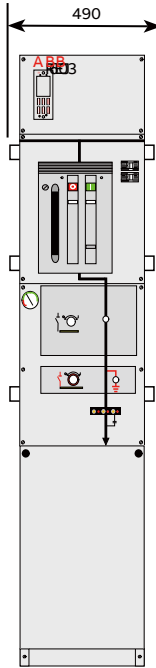

Floor and wall fixing including cable entry

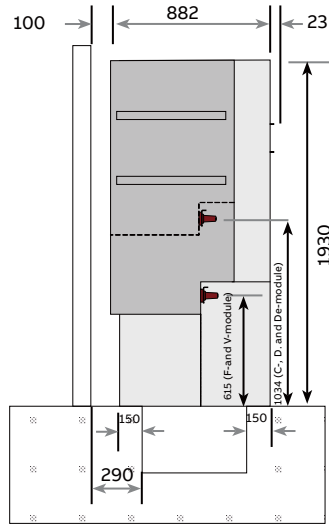

Cable trench and wall fixing

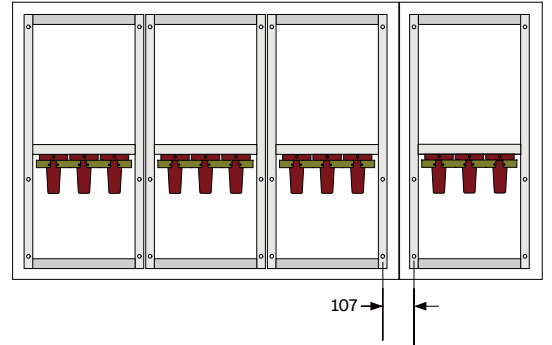

Distance between two units which are connected to each other by means of external busbars

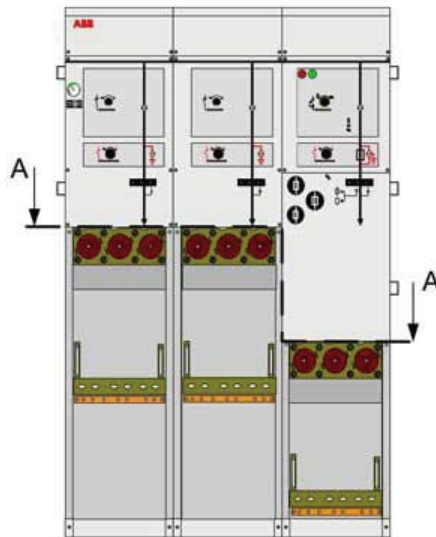

3-way unit with removed cable compartment covers

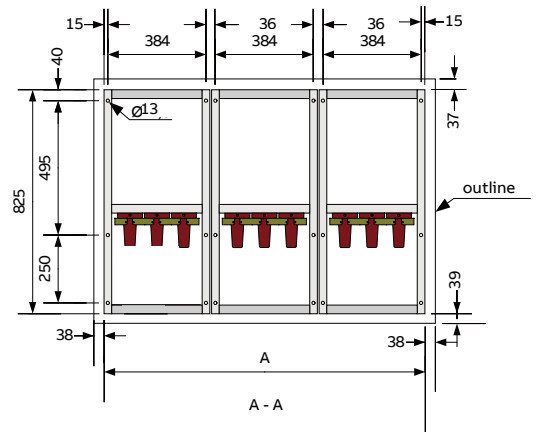

Unit	1-way	2-way	3-way	4-way
A (mm)	420	840	1260	1680

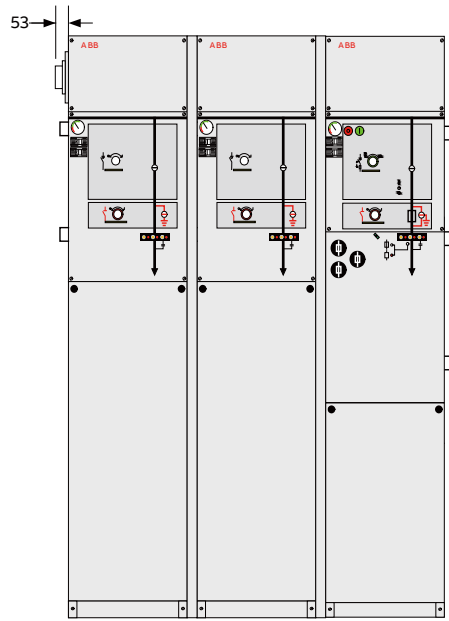

Side extension

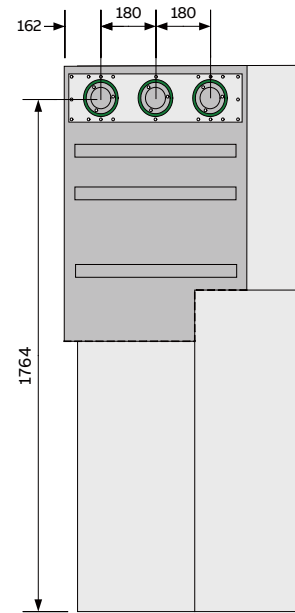

SafeRing 36kV CCF with dead end receptacles on left hand side (also available on right hand side)

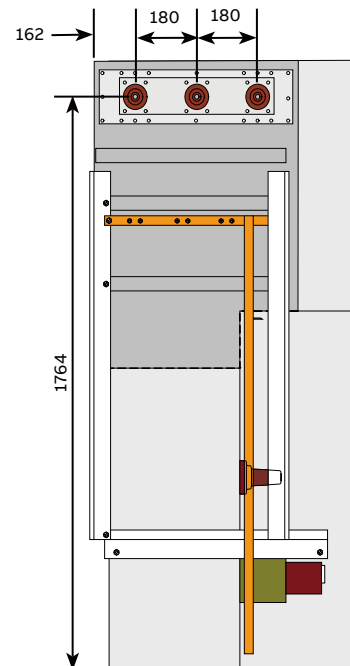
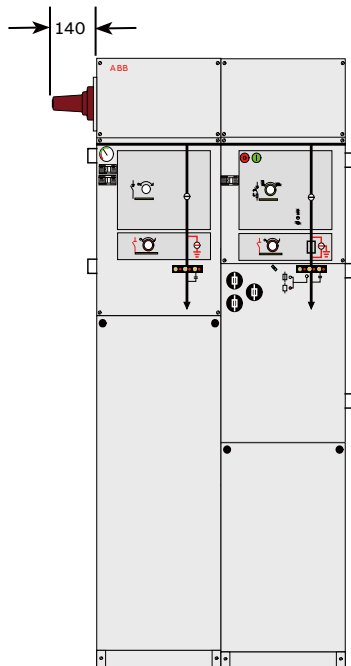

SafePlus 36kV CF with cable bushings on left hand side (also available on right hand side)

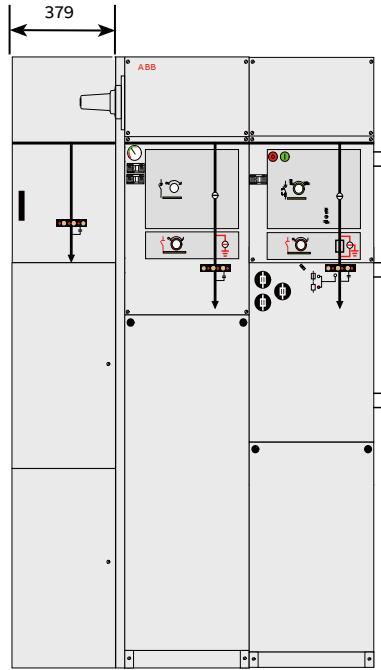

SafePlus 36kV CF with cover on left hand side

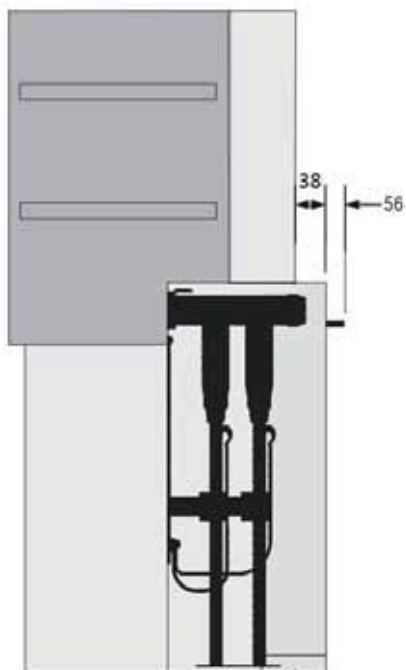

Cable compartment cover for parallel cables

Technical data

IEC 62271-1	High-voltage switchgear and controlgear -Part 1: Common specifications
IEC 62271-100	High-voltage switchgear and controlgear - Part 100: High-voltage alternating-current circuit-breakers
IEC 62271-102	High-voltage switchgear and controlgear - Part 102: Alternating current disconnectors and earthing switches
IEC 62271-105	
IEC 62271-200	High-voltage switchgear and controlgear - Part 105: Alternating current switch-fuse combinations
IEC 60265-1	High-voltage switchgear and controlgear - Part 200: A.C. metal-enclosed switchgear and controlgear for rated voltages above 1 kV and up to and including 52 kV
IEC 60529	High-voltage switches- Part 1: Switches for rated voltages above 1 kV and less than 52 kV Degrees of protection provided by enclosures (IP code)

SafeRing 36-Ring main unit, electrical data and service conditions

NO	Rated voltage	kV	36					38.5					38					40.5				
1	Rated frequency	Hz	50	60	50	60	50	60	50	60	50	60	50	60	50	60	50	60	50	60		
2	Power frequency withstand voltage	kV	70	70	80	80	95	95	118													
	- Across disconnecter	kV	80	80	95	95	118															
3	Lightning impulse withstand voltage	kV	170	150	180	150	185															
	- Across disconnecter	kV	195	165	210	165	215															
4	Rated normal current busbars	A	630	600	630	600	630															
5	Rated normal current (cable switch)	A	630	600	630	600	630															
6	Rated normal current (switch-fuse disconnecter)	A	See ¹⁾		See ¹⁾		See ¹⁾															
7	Rated normal current (vacuum circuit-breaker)	A	630	600	630	600	630															
	Breaking capacities:																					
8	Active load (cable switch)	A	630	600	630	600	630															
9	Active load (vacuum circuit-breaker)	A	630	600	630	600	630															
10	Rated short-circuit breaking current (vacuum circuit-breaker)	kA	20		20		20															
	- Class 5)		E1, S1	E1, S1	E1, S1	E1, S1	E1, S1															
	-D.C.component	%	41	30	33	25	33															
11	Closed loop (cable switch)	A	630	600	630	600	630															
12	Off load cable charging (cable switch)	A	20	20	21	21	21															
13	Earth fault (cable switch)	A	60	60	63	63	63															
14	Earth fault cable charging (cable switch)	A	35	35	36	36	36															
15	Rated cable-charging breaking current (vacuum circuit-breaker)	A	50		50		50															
			(Class C1)		(Class C1)		(Class C1)															
16	Rated transfer current (switch-fuse disconnecter)	A	840		750		840															
17	Rated making capacity (cable switch) E3-5 times	kA	50	52.5	50	52.5	50															
18	Rated making capacity (downstream earthing switch in F-module) E2-5 times	kA	2.5		2.5		2.5															
19	Rated short time current 3 sec.	kA	20	20	20	20	20															
20	Rated short time current 1 sec. (downstream earthing switch in F-module)	kA	1		1		1															
21	Rated short-time current (earthing switch)	kA	20	20	20	20	20															
22	Rated short-circuit making current (earthing switch) E2-5 times	kA	50	52.5	50	52.5	50															
23	Rated filling level for insulation	MPa	0.04	0.04	0.04	0.04	0.04															
	Service conditions for indoor equipment according to IEC 62271-1																					
	Ambient temperature																					
24	Maximum value	°C	+40 ²⁾	+40 ²⁾	+40 ²⁾	+40 ²⁾	+40 ²⁾															
25	Maximum value of 24 hours mean	°C	+35	+35	+35	+35	+35															
26	Minimum value	°C	-25	-25	-25	-25	-25															
27	Altitude for erection above sea level	m	...1500 ³⁾	...1500 ³⁾	...1500 ³⁾	...1500 ³⁾	...1500 ³⁾															
28	Relative humidity		max 95%	max 95%	max 95%	max 95%	max 95%															

1) Depending on the current rating of the fuse-link.

2) Derating allows for higher maximum temperature.

3) For higher altitude, reduced gas pressure is required.

4) Valid with Interface C bushings (400 series bolted type) only.

5) Class E2 without auto-reclosing.

SafeRing 36-compact switchgear, electrical data

N0	Rated voltage	kV	36	38.5	38	40.5	
1	Rated frequency	Hz	50	60	50	60	50
2	Power frequency withstand voltage	kV	70	70	80	80	95
	- Across disconnecter	kV	80	80	95	95	118
3	Lightning impulse withstand voltage	kV	170	150	180	150	185
	- Across disconnecter	kV	195	165	210	165	215
4	Rated normal current busbars	A	630	600	630	600	630
5	Rated normal current (cable switch)	A	630	600	630	600	630
6	Rated normal current (switch-fuse disconnecter)	A	See ¹⁾		See ¹⁾		See ¹⁾
7	Rated normal current (vacuum circuit-breaker)	A	630	600	630	600	630
	Breaking capacities:						
8	Active load (cable switch)	A	630	600	630	600	630
9	Active load (vacuum circuit-breaker)	A	630	600	630	600	630
10	Rated short-circuit breaking current (vacuum circuit-breaker)	kA	20	20	20	20	20
	- Class 5)		E1, S1	E1, S1	E1, S1	E1, S1	E1, S1
	-D. C. component	%	41	30	33	25	33
11	Closed loop (cable switch)	A	630	600	630	600	630
12	Off load cable charging (cable switch)	A	20	20	21	21	21
13	Earth fault (cable switch)	A	60	60	63	63	63
14	Earth fault cable charging (cable switch)	A	35	35	36	36	36
15	Rated cable-charging breaking current (vacuum circuit-breaker)	A	50		50		50
			(Class C1)		(Class C1)		(Class C1)
16	Rated transfer current (switch-fuse disconnecter)	A	840		750		750
17	Rated making capacity (cable switch) E3-5 times	kA	50	52.5	50	52.5	50
18	Rated making capacity (downstream earthing switch in F-module) E2-5 times	kA	2.5		2.5		2.5
19	Rated short time current 2 sec.	kA	20	20	20	20	20
20	Rated short time current 3 sec.	kA	20 ⁴⁾		20 ⁴⁾		20 ⁴⁾
21	Rated short time current 1 sec. (downstream earthing switch in F-module)	kA	1		1		1
22	Rated short-time current (earthing switch)	kA	20	20	20	20	20
23	Rated short-circuit making current (earthing switch)	kA	50	52.5	50	52.5	50
	Rated filling level for insulation	MPa	0.04	0.04	0.04	0.04	0.04
	Service conditions for indoor equipment according to IEC 62271-1						
24	Ambient temperature						
25	Maximum value	°C	+40 ²⁾	+40 ²⁾	+40 ²⁾	+40 ²⁾	+40 ²⁾
26	Maximum value of 24 hours mean	°C	+35	+35	+35	+35	+35
27	Minimum value	°C	-25	-25	-25	-25	-25
28	Altitude for erection above sea level	m	...1500 ³⁾	...1500 ³⁾	...1500 ³⁾	...1500 ³⁾	...1500 ³⁾
29	Relative humidity		max 95%	max 95%	max 95%	max 95%	max 95%

1) Depending on the current rating of the fuse-link.

2) Derating allows for higher maximum temperature.

3) For higher altitude, reduced gas pressure is required.

4) Valid with Interface C bushings (400 series bolted type) only.

5) Class E2 without auto-reclosing.

General data, enclosure and dimensions

1	Standard to which switchgear complies	IEC / GB
2	Type of Ring Main Unit	Metal enclosed
3	Number of phases	3
4	Whether RMU is type tested	Yes
5	Pressure test on equipment tank or containers	Until pressure relief device opens
6	Whether facility is provided with pressure relief device	Yes
7	Insulating gas	SF ₆
8	Nominal operating gas pressure	1.4 bar abs. at 20°C
9	Gas diffusion rate	0.1 % p.a.
10	Expected operating lifetime	30 years
11	Whether facilities are provided for gas monitoring	Yes, temperature compensated manometer can be delivered
12	Material used in tank construction	Stainless steel sheet, 2 mm
13	Busbars	300 mm ² Cu
14	Earth bar (external)	120 mm ² Cu
15	Earth bar bolt dimension	M10

Overall dimensions of fully assembled ring main unit			Height	Depth	Width
16	1-way unit	mm	1930	900	490
17	2-way unit	mm	1930	900	910
18	3-way unit	mm	1930	900	1330
19	4-way unit	mm	1930	900	1750

Weight table
Maximum weights for standard SafeRing 36 kV:

2-way DeV	550 kg	2-way DeF	550 kg
3-way CCV	800 kg	3-way CCF	800 kg
4-way CCCV	1050 kg	4-way CCCF	1050 kg
4-way CCVV	1100 kg	4-way CCFF	1100 kg
3-way CCC	750 kg		
4-way CCCC	1000 kg		

SafePlus 36 kV:

Standard 1-way (C-, D-, De-module)	250 kg
Standard 1-way (F-, V-module)	300 kg
2-, 3- and 4-way	as for SafeRing
M – metering module	600 kg

Operations, degree of protection and colours

1	Means of switch-disconnector operation	Separate handle
2	Means of fuse-switch-disconnector operation	Separate handle and push-buttons and/or opening and closing trip coils
3	Means of circuit-breaker operation	Integrated handle and push-buttons and/or opening and closing trip coils
4	Rated operating sequence of circuit-breaker	O - 0,3 s - CO - 15 s - CO
5	Total opening time of circuit-breaker	Approx. 40 - 80 ms
6	Closing time of circuit-breaker	Approx. 40 - 70 ms
7	Mechanical operations of switch-disconnector	1000 CO (Class M1)
8	Mechanical operations of earthing switch	1000 CO
9	Mechanical operations of circuit-breaker	2000 CO (Class M1)
10	Principle switch-disconnector	2 position puffer switch
11	Principle earthing switch	2 position earthing switch with downstream earthing switch in F-modules
12	Principle circuit-breaker	Vacuum interrupter with axial magnetic field contacts
Load break switch:		
13	Rated operations on short circuit current (class E3)	5
14	Rated operations mainly active load	100
Degree of protection:		
15	High voltage live parts, SF ₆ tank	IP 67
16	Front covers/operating mechanisms	IP 2X
17	Cable covers	IP 3X
18	Fuse canisters	IP 67
Colours:		
19	Front covers	RAL 7035
20	Side and cable covers	RAL 7035
21	Switch area	Medium grey pantone 429C

Fuse-links

1	Standard fuse-link length	537 mm
2	Standard dimensions	According to DIN 43625
3	Maximum size 36 kV	63 A

Curves, number of operations

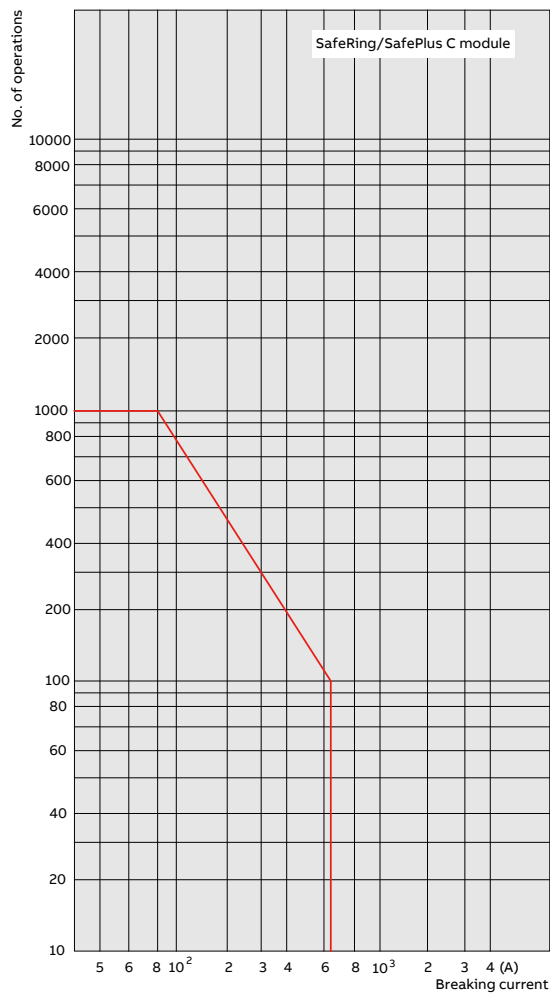
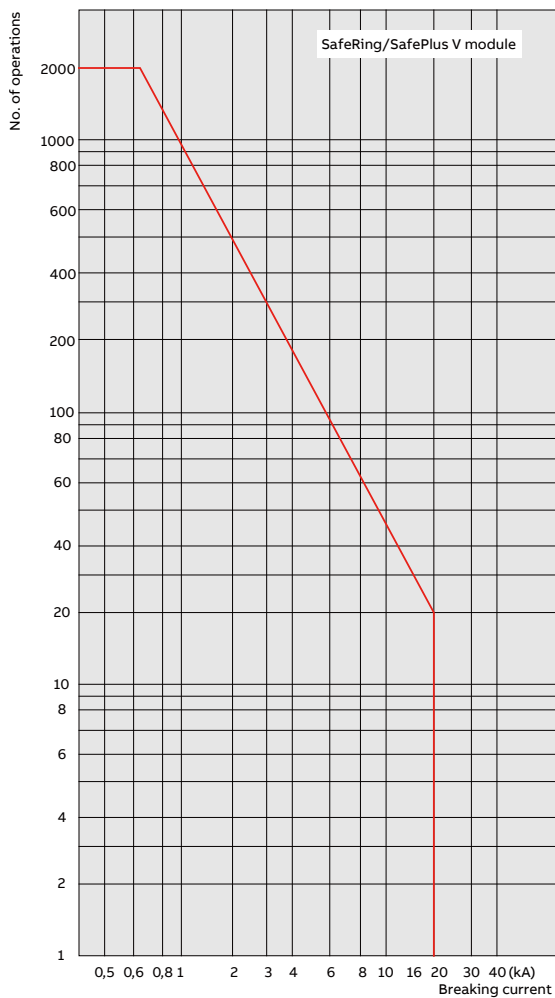

Environmental certification

Life expectancy of product

The product is developed in compliance with the requirements denoted by IEC 62271-200. The design incorporates a life span under indoor service conditions exceeding 30 years.

The switchgear is gas-tight with an expected diffusion rate of less than 0.1 % per annum. Referring to the reference pressure of 1.4 bar, the switchgear will maintain gas-tightness and a gas-pressure better than 1.3 bar at 20°C throughout its designed life span.

Recycling capability

Raw material	Weight (kg)	% of total weight	Recycle	Environmental effects & recycle/reuse processes & ú & ú & ú
Iron	139.9	31.1	Yes	Separate, utilise in favour of new source (ore)
Stainless steel	130.8	29.1	Yes	Separate, utilise in favour of new source (ore)
Copper	71.9	16.0	Yes	Separate, utilise in favour of new source (ore)
Brass	3.0	0.7	Yes	Separate, utilise in favour of new source (ore)
Aluminium	1.0	0.2	Yes	Separate, utilise in favour of new source (ore)
Zinc	5.1	1.2	Yes	Separate, utilise in favour of new source (ore)
Silver	0.075	0.014	Yes	Electrolysis, utilise in favour of new source
PBT	2.3	0.5	Yes	Make granulate, re-use or apply as energy
PA6-6	5.3	1.2	Yes	
PC	0.8	0.2	Yes	
Other thermoplastic	0.1	0	Yes	
Packing foil	0.3	0.1	Yes	High-grade energy additive in refuse incineration
SF ₆ gas	5.4	1.2	Yes	Reclaim
Dielectric oil	0.3	0.1	Yes	Collect/reclaim/regenerate
Wooden pallet	27.8	6.2	Yes	Re-use
Total recycleables	394.075	89.0		
Rubber	1.9	0.4	No	Incinerate energy in rubber
Epoxy compounds	46.5	10.3	No	Contains 60% quartz sand, incinerate energy in epoxy
Unspecified	1.5	0.3	No	Stickers, film foils, powder coating, lubricates
Total non-recycleables	49.8	10.8		
Total weight **	443.875	100 %		

***) All figures are collected from CCF 3-way unit with fuse canisters.

Lifecycle concept for transport, installation, repair, service and disposal at end of life

ABB is committed to the protection of the environment and adhere to ISO 14001 standards. The unit contains no substances listed on the hazardous substances list.

The unit contains SF₆ with 0,4 bar overpressure in a maintenance free and sealed unit. The unit is a sealed pressure system and restrictions for air transport exist. Units damaged during transport are returned to the manufacturer for inspection and possible repair.

SF₆ is a fluorinated greenhouse gas covered by the Kyoto Protocol and care must be taken

not to cause emission of SF₆ and at end-of-life the greenhouse gas must be recovered. It is ABB's obligation to facilitate end-of-life recycling for our products. In the EU and EEA, the F-Gas regulation must be followed.

ABB's recycling service is according to IEC 61634 edition 1995 section 6: «End of life of SF₆ filled equipment» and in particular 6.5.2.a: «Low decomposition»: «No special action is required; non-recoverable parts can be disposed of normally according to local regulations.»

We also advise customer always to consult ABB's website : <http://www.abb.com/sf6> .

ISO-Certificates





ABB Beijing Switchgear Limited

3F, Building No. 2, No. 12 Jingyuan Street,
Beijing Economic and Technological Development Zone,
Beijing, China
Tel: 010-6781 8000
Fax: 010-6781 8001

ABB China Customer Service Hot Line

TEL: 800-820-9696 / 400-820-9696
mail: cn-ep-hotline@abb.com

www.abb.com